

DISHWASHERS
SOLO SERVICE MANUAL



SERIES A

TOOLS FOR DISASSEMBLE



Phillips screwdriver

- *All kinds of star-head screws,
- *in the phillips screws of the internal components,



Plier

- *It is used to bend all kinds of sheet metal ends.



Multimeter

- *Resistance values of all kinds of internal components,
- *Electronic card resistors,
- *It is used to measure the resistance of display cards.



Flat Screwdriver

It is used to remove all kinds of aesthetic parts (side panels, front panels and external aesthetic parts of the machine).



SideCutter

It is used to cut cables of internal components or any hard part.



Chargeable Drill

It is the most important tool used to remove and install all kinds of screws in the machine.



Do not touch the electronic card without gloves and gloves must be clean.



Do not touch the electronic board without ESD protection equipments(Heel straps, ESD gloves etc.)



Be sure that any of the external material(oil, dirt, liquid etc.) should not be transferred to the card.

TABLE OF CONTENTS

TABLE OF CONTENTS	i
1. USER INTERFACE AND SOFTWARE	1
1.1. User Interface Versions:	1
A SERIES W/O DISPLAY(A11, A12,A13,A14, A15,A16,A17)	1
A SERIES W/O DISPLAY W/ AUTODOOR (A11_O, A12_O,A13_O,A14_O, A15_O,A16_O,A17_O)	3
A SERIES W DISPLAY-W/O DIVERTER(A1A, A1B,A1C,A1D,A1E,A1F,A1G).....	5
A2 SERIES W/ AUTODOOR (A21_O, A22_O, A23_O).....	14
A3 SERIES (A31,A32,A33,A34,A35,A36,A37,A38,A39, A3X, A3Y,A3Y_UVC, A31_O, A32_O)	15
A3 SERIES W/ AUTODOOR (A31_O, A32_O).....	18
A4 display energy and water bars:.....	22
Models Without Salt Tank: A15_AUS, A21_AUS, A23_AUS	22
1.2. Washing Programmes	23
WASHING PROGRAM CROSS TABLE	23
PROGRAMME SEQUENCES.....	25
1.3. WASHING SPECIFICATIONS AND PROGRAMS.....	39
2. ELECTRICAL COMPONENTS AND MEASUREMENTS	105
2.1. Door Lock:.....	105
2.2. Circulation Pump:.....	105
2.3. Circulation Pump Capacitor:.....	107
2.4. Drain Pump:	107
2.5. Heater:.....	108
2.6. Ntc:	108
2.7. Pressure Switch:.....	109
2.8. Diverter:.....	109
2.9. Water Inlet Valve:.....	111
2.10. Regeneration Valve:	112
2.11. Parasite Filter	113
2.12. Turbo Fan:	113
2.13. Salt Sensor	114
2.14. Power Cord:.....	114
2.15. Rinse Aid Sensor:	115
2.16. Door Switch:	117
2.17. Floater:	118
2.18. Salt Sensor:	119
2.19. Pressure Switch:	120
2.20. Detergent Dispenser:	121
3. DISASSEMBLY OF COMPONENTS	122
3.1. Tools to Be Used.....	122

3.2. Assembly and Disassembly Instructions of Components.....	123
3.2.1. Top Plate:.....	123
3.2.2. Plastic Kick Plate:	123
3.2.3. Internal Feeding Tube and Spray Arms:	124
3.2.4. Micro Filter and Metal Filter:	125
3.2.5. Draining hose:.....	126
3.2.6. Lower basket	126
3.2.7. Upper basket	126
3.2.8. Water Inlet valve.....	127
3.2.9. Turbo Fan	128
3.2.10. Sump Group.....	130
3.2.11. Floater	132
3.2.12. Water softener	133
3.2.13. Parasite filter	134
3.2.16. Circulation Pump	136
3.2.17. Regeneration valve:.....	137
3.2.18. Drain pump:.....	137
3.2.19. Power cord:.....	138
3.2.20. Hose connection plastic:.....	139
3.2.21. Airbreak:	140
3.2.22. Door Hinge:	141
3.2.23. Dispenser:.....	142
3.2.24. Door Lock:.....	143
3.2.25. Electronic Board:	144
3.2.26. Control Panel:	145
3.2.27. Kick Plate Sheet Iron	146
3.2.28. Front Panel	147
3.2.29. Side panels	147
3.2.30. Inner Light Source:	149
3.2.31. Aluminum Foil Tape of Handle on Control Panel:.....	150
3.2.32. NTC	155
3.2.33. Heater.....	156

1. USER INTERFACE AND SOFTWARE

1.1. User Interface Versions:

A SERIES W/O DISPLAY(A11, A12,A13,A14, A15,A16,A17)

The user interface includes:

- On/Off button with integrated led
- Up/down button
- Program leds
- Half Load button with integrated led(Half Load led)
- Tablet button with integrated led (Tablet led)
- Delay button
- Delay durations with 2 leds
- Rinse aid and Salt leds
- Child lock led
- Program status with Wash, Dry and End leds
- Start/Stop and Reset button with integrated led

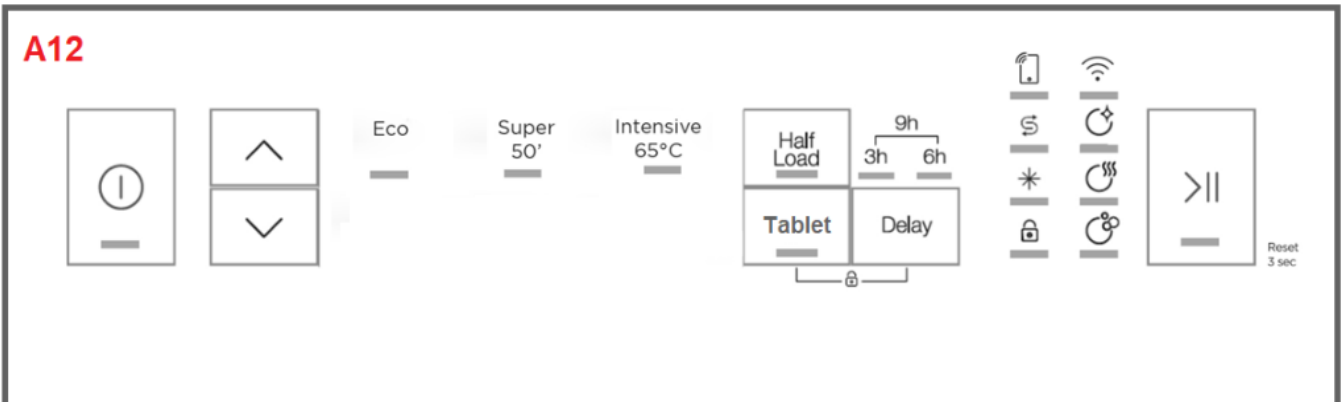
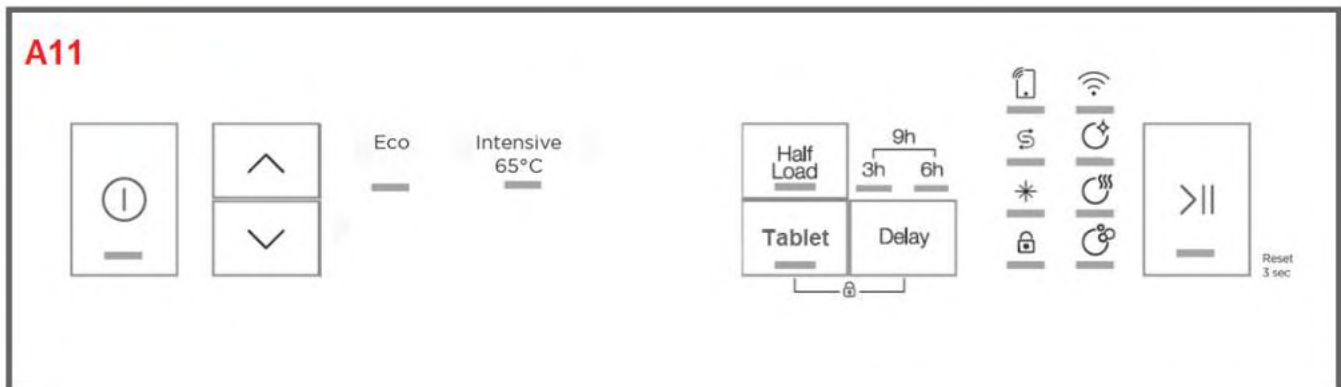

A13

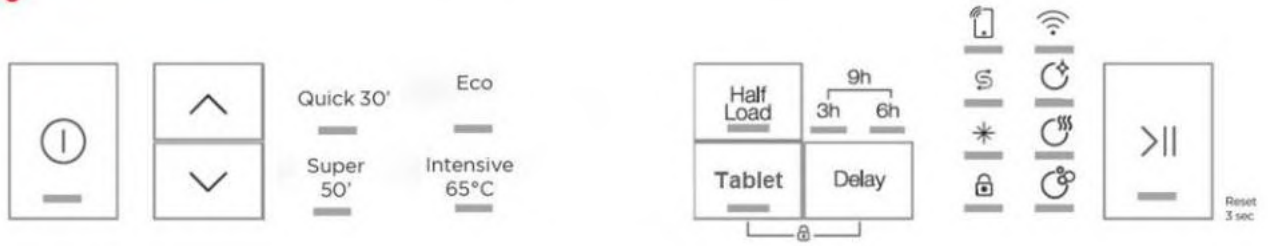

A14

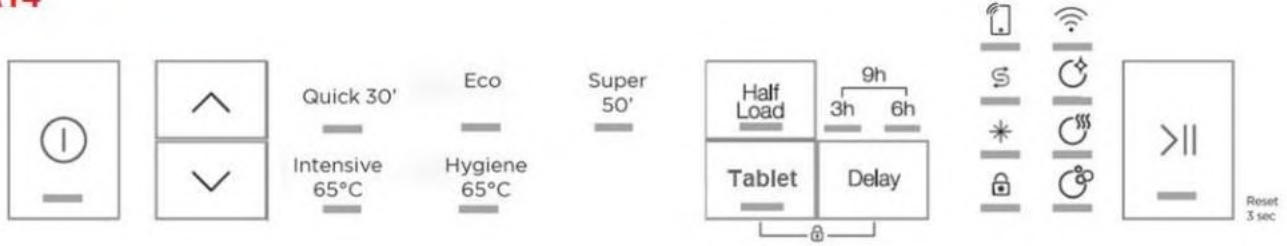

A15

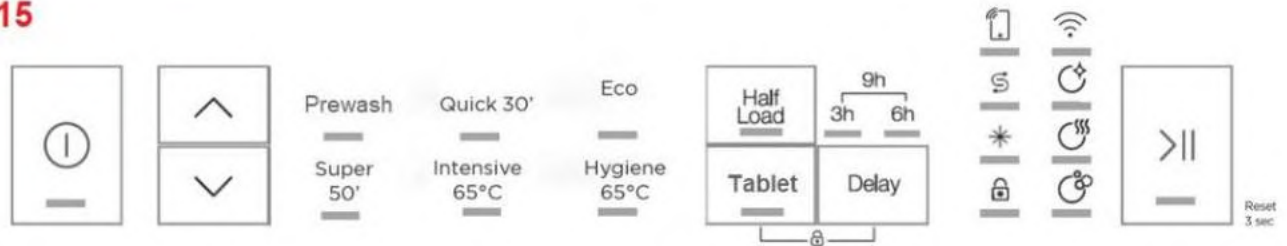

A16

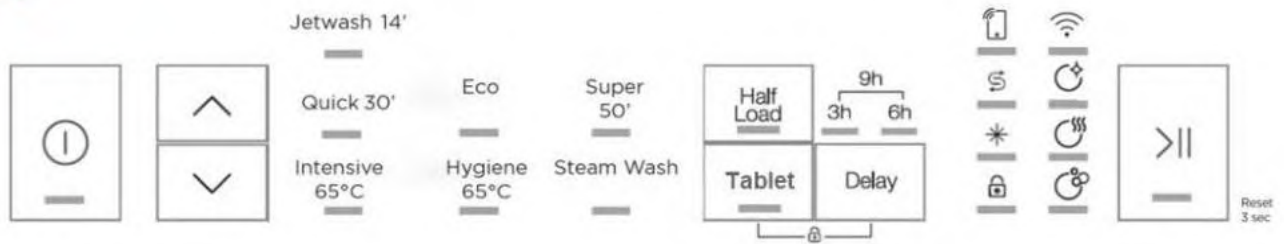

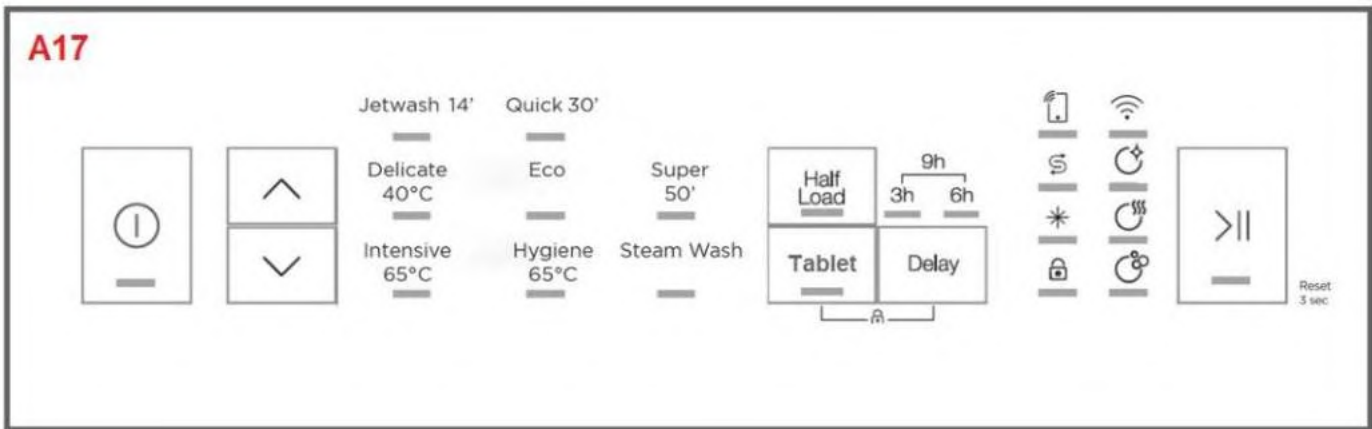

A SERIES W/O DISPLAY W/ AUTODOOR (A11 O, A12 O, A13 O, A14 O, A15 O, A16 O, A17 O)

The user interface includes:

- On/Off button with integrated led
- Up/down button
- Program leds
- Half Load button with integrated led(Half Load led)
- **Energy Save button with integrated led (Energy Save led)**
- Delay button
- Delay durations with 2 leds
- Rinse aid and Salt leds
- Child lock led
- Program status with Wash, Dry and End leds
- Start/Stop and Reset button with integrated led

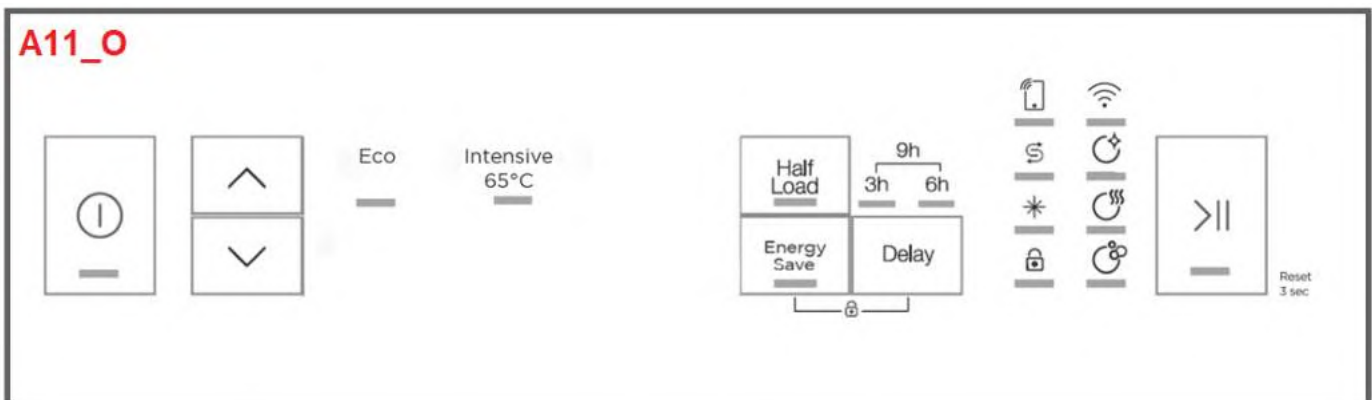

A12_O

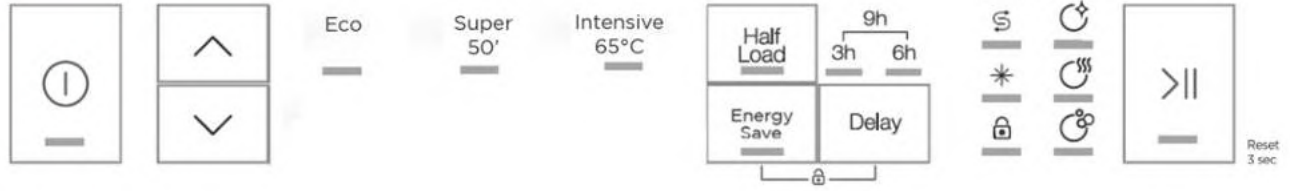

A13_O



A14_O

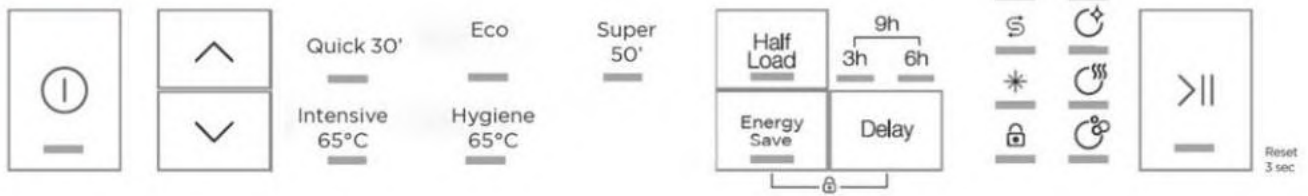

A15_O

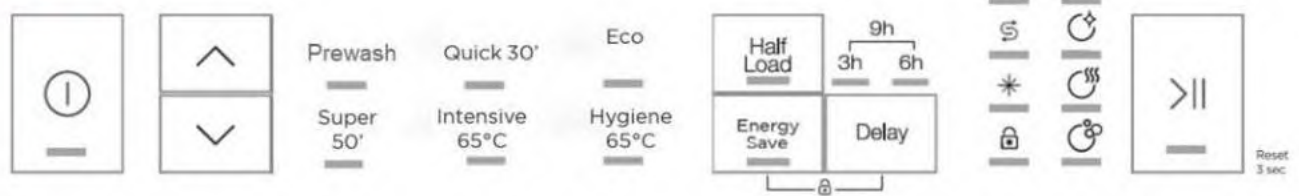

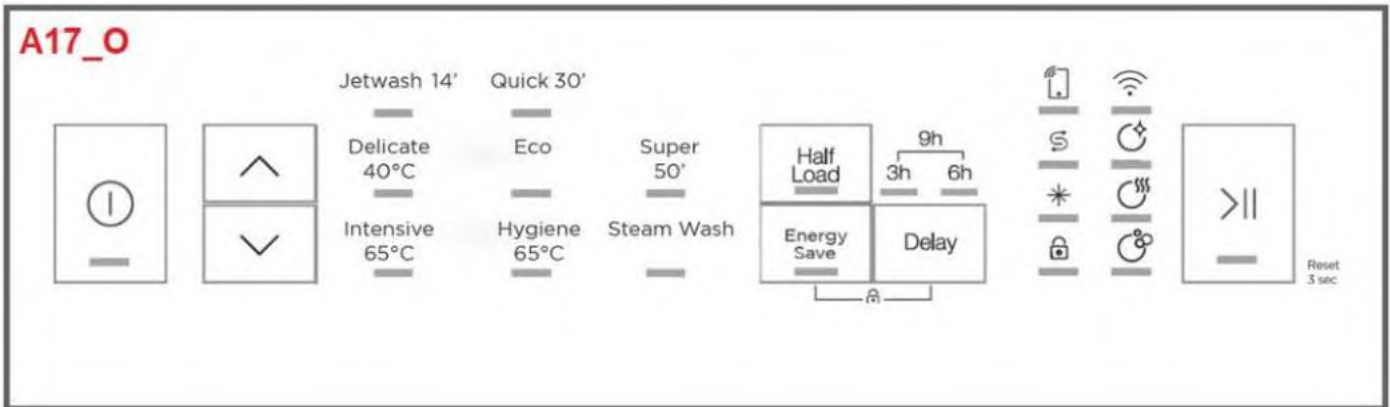
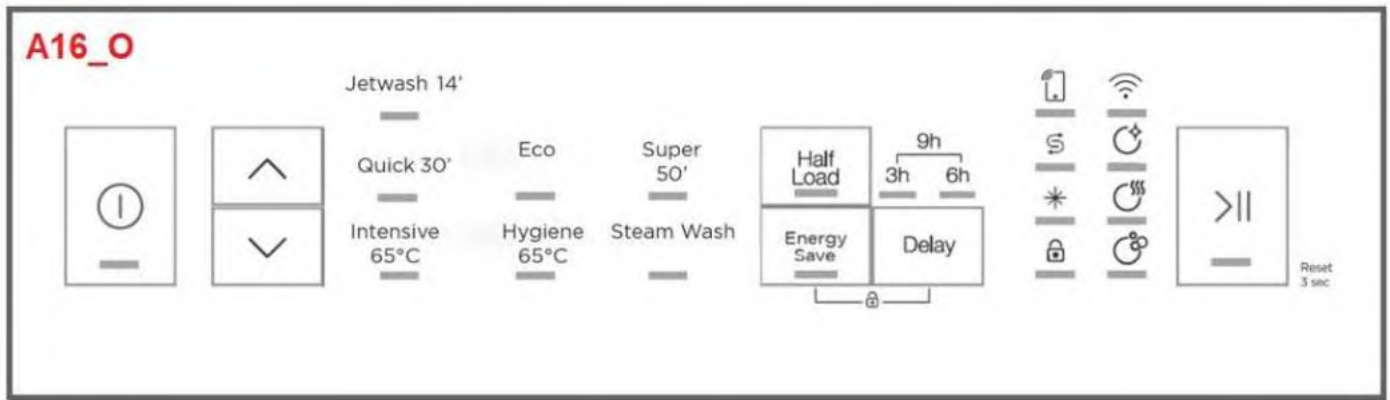

A SERIES W DISPLAY-W/O DIVERTER(A1A, A1B,A1C,A1D,A1E,A1F,A1G)

The user interface includes:

- On/Off button
- Program button
- Program leds
- Delay button
- Rinse aid and Salt leds
- 888 display with “delay timer active”, Half Load, Tablet icons
- Program status with Wash, Rinse, Dry and End leds
- Start/Stop and Reset button
- Half Load button
- Tablet button



A1B



A1C



A1D



A1E





Note: At the beginning date of 09.10.2020, for all A1 digit and A2 models;

- In A1 digit and A2 models; When the program is stopped, in addition to the S/P led, the washing progress (wash-rinse-dry) led should also blink.
- A1 digit models; When HL or Tablet options are selected, the corresponding icon under 888 should light up in addition to the leds on its own button (as in the display software used for Carya-Erica).

1.2 A SERIES W/ DISPLAY, W/ AUTODOOR (A1A_O, A1B_O, A1C_O, A1D_O, A1E_O)

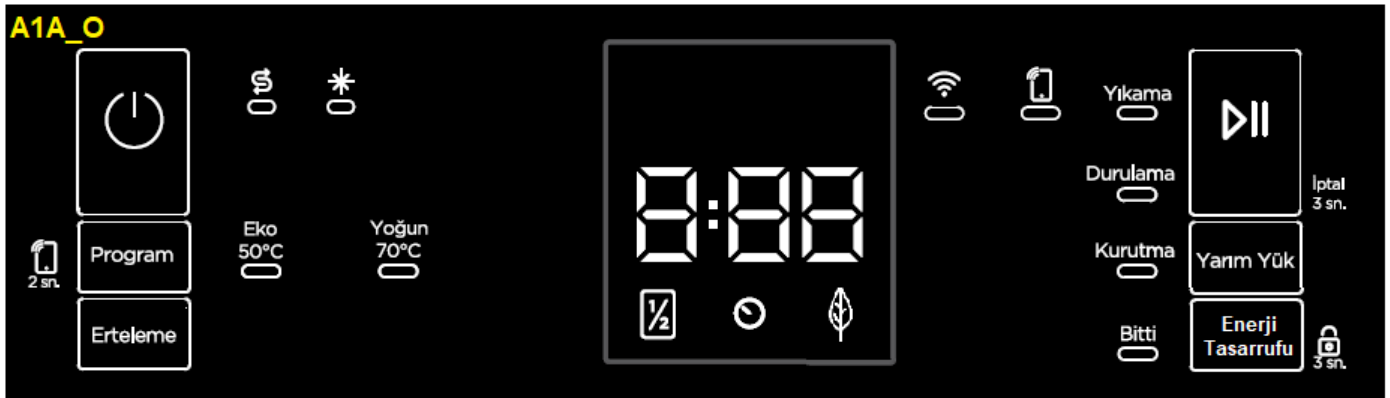

A1B_O



A1C_O



A1D_O

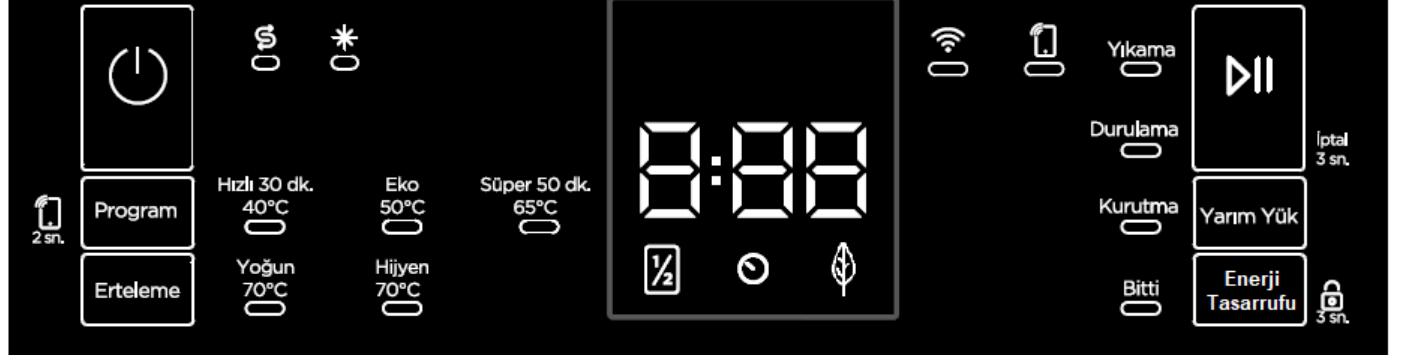

A1E_O





1.3 A1A ~A1E_ELS (Exclusive to Electroscaandia customer)





1.6 A2 SERIES (A21,A22,A23,A24,A25,A26,A27,A28,A29, A2X, A21_O, A22_O, A23_O, A26_ELS, A27_ELS, A28_ELS, A29_ELS)

The user interface includes:

- On/Off button with integrated led
- Program button
- Program leds
- Delay button
- Rinse aid and Salt leds
- 888 display with “delay timer active” icon
- Program status with Wash, Rinse, Dry and End leds
- Start/Stop and Reset button with integrated led
- Half Load button with integrated led(Half Load led)
- Tablet button with integrated led (Tablet led)

A21

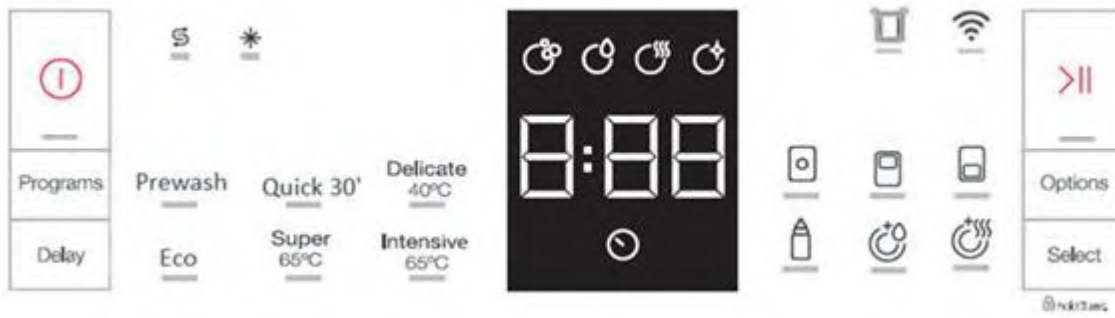

A22

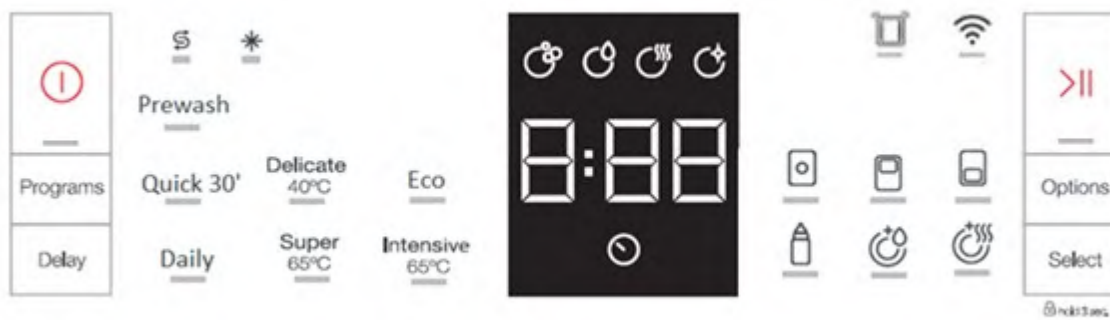

A23

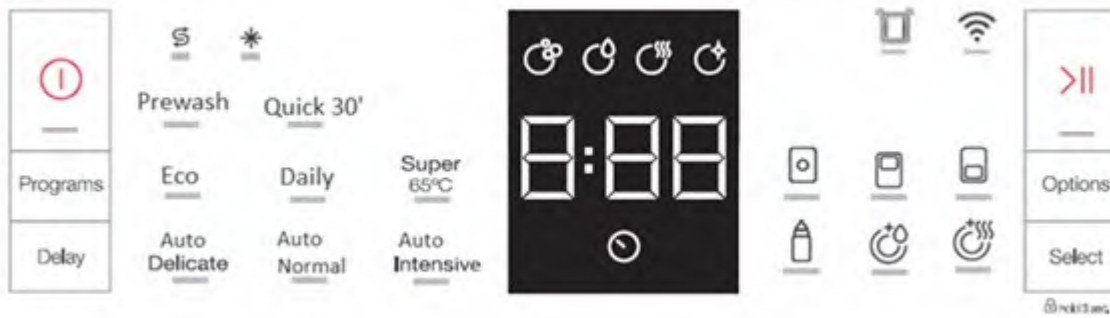

A24

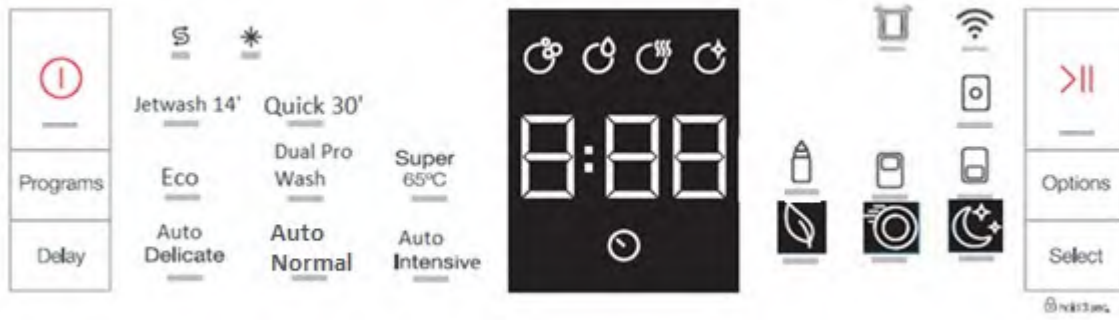

A25



NEW MODELS; old A26 model control panel is removed, and new model panels are added instead. (28.07.2021)

A26

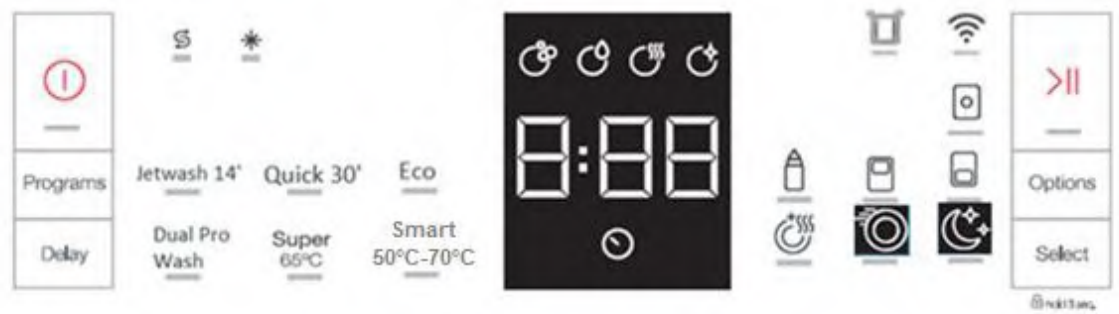

A27



A28



A29

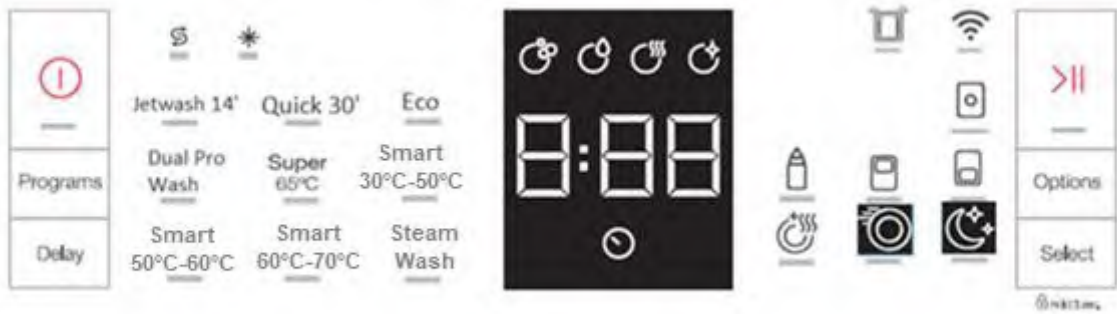

A2X



A2 SERIES W/ AUTODOOR (A21_O, A22_O, A23_O)

A21_O

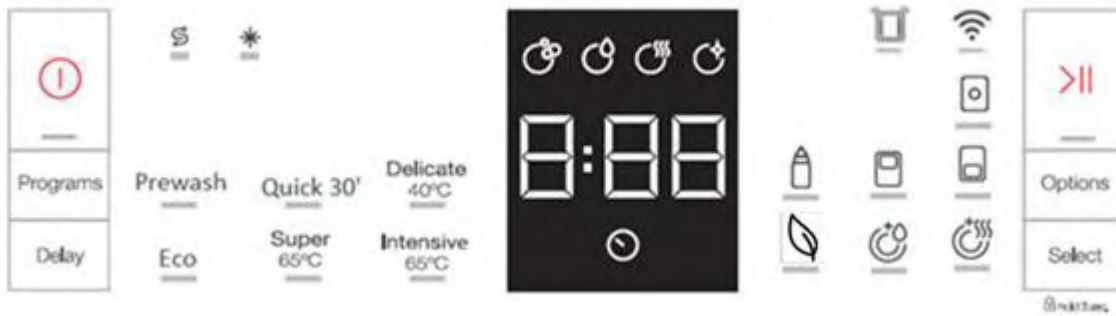

A22_O



A23_O

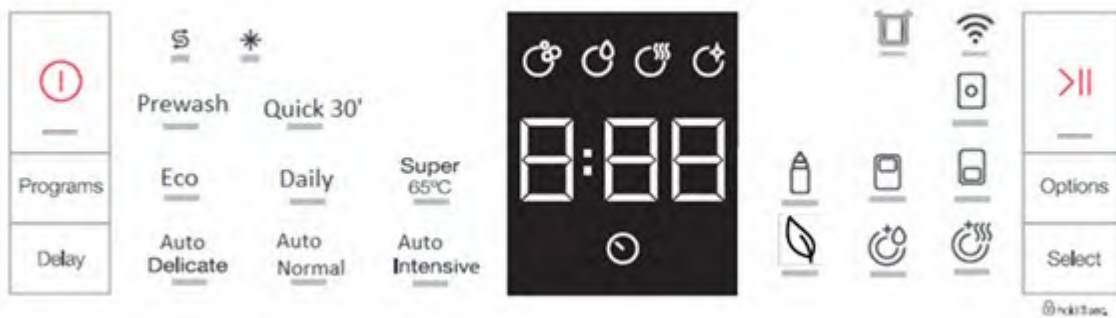

A26_ELS, A27_ELS, A28_ELS, A29_ELS (Exclusive to Electroscandia customer)

Note: In A26-A27-A28-A29_ELS models, when the machine is turned on, it turns on in Eco (without option). Unlike other models, when switching from Eco to other programs, the Tablet option is selected in all. In addition, Auto programs come after Eco in the program placement.

A26_ELS



A27_ELS

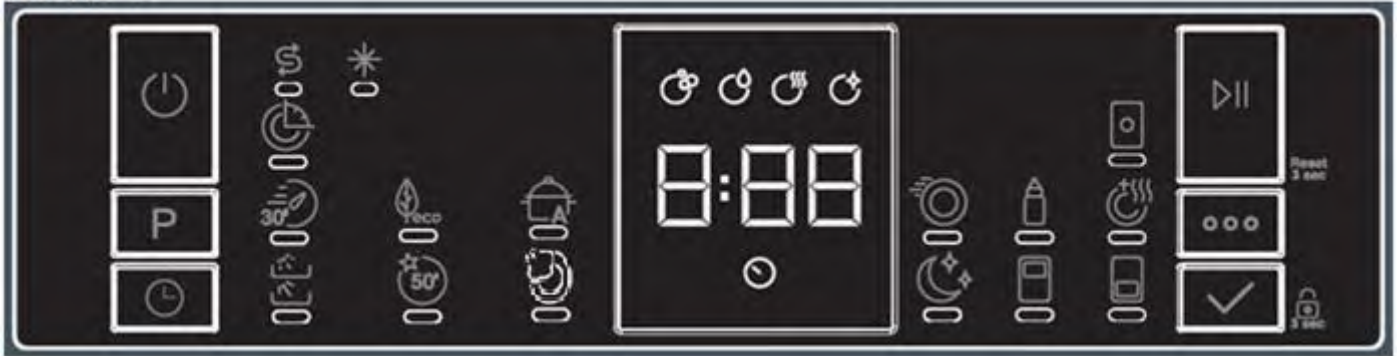

A28_ELS

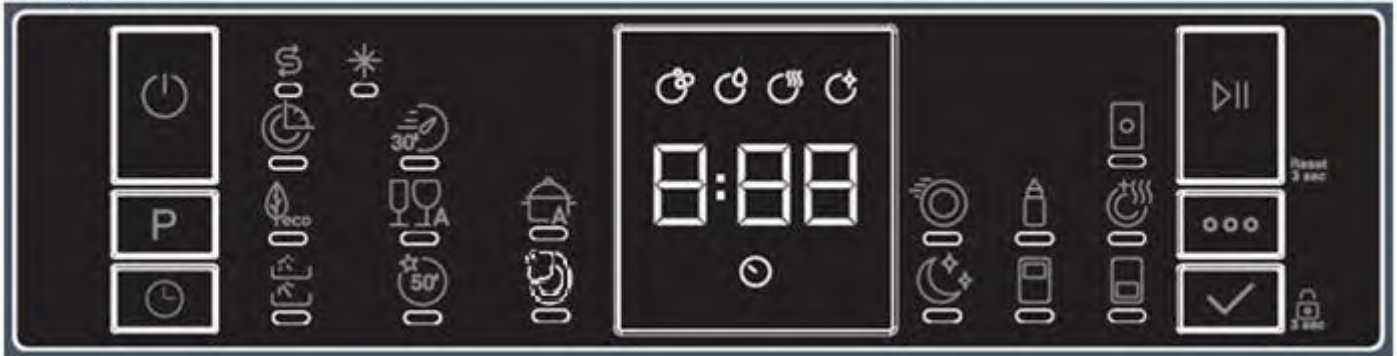

A29_ELS



A3 SERIES (A31,A32,A33,A34,A35,A36,A37,A38,A39, A3X, A3Y,A3Y_UVC, A31_O, A32_O)

The user interface includes:

- On/Off button

- Program button
- Program icons
- Delay button
- Rinse aid and Salt icons
- 888 display
- “delay timer active” icon
- Program status with Wash, Rinse, Dry and End icons
- Start/Stop and Reset button
- Option button
- Select button





NEW MODELS; old A36 model control panel is removed, and new model panels are added instead. (28.07.2021)



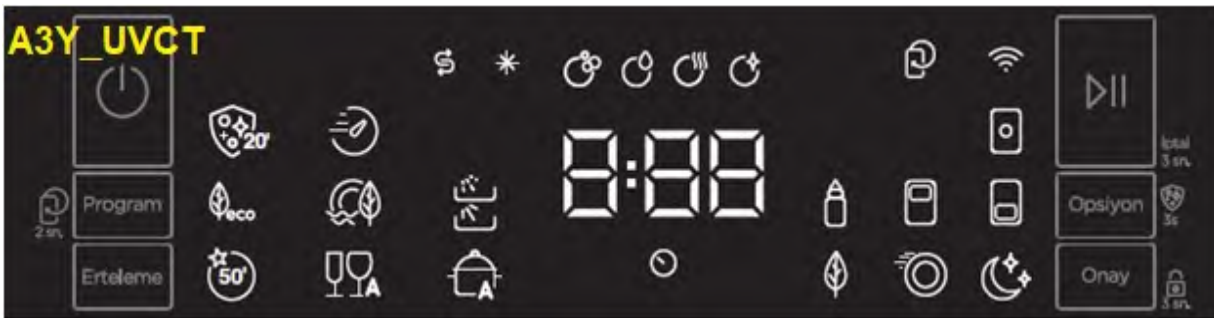

Note: Compared to the A3Y model; on the A3Y_UVCT model, only the Mini 14' program is removed and replaced with the UVC "WaterFree 20" program. (13.08.2021)

A3 SERIES W/ AUTODOOR (A31 O, A32 O)



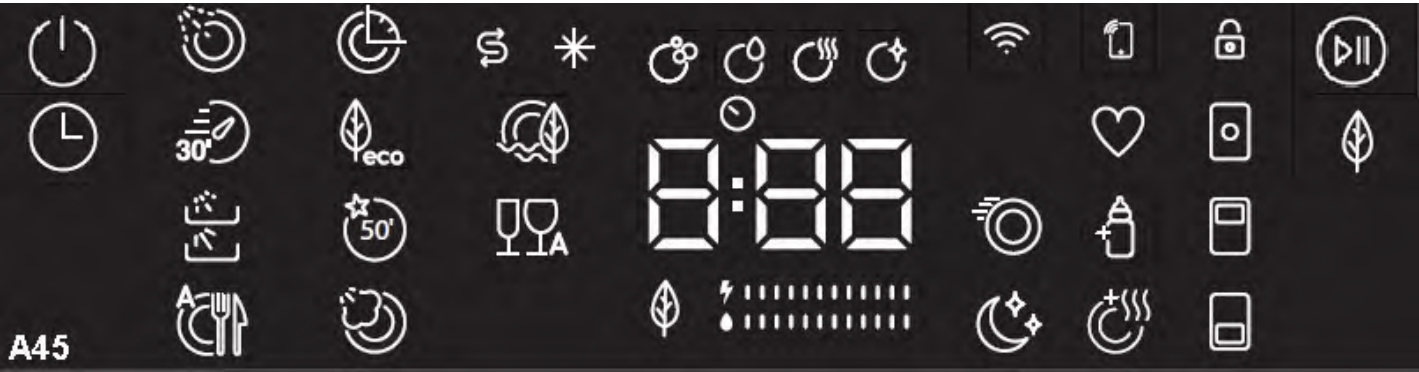
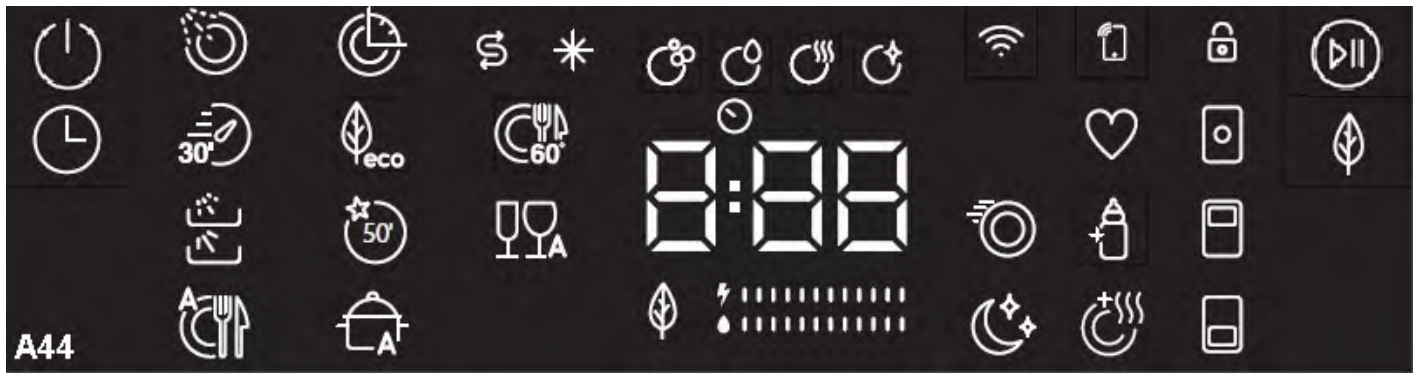

NEW MODELS (28.07.2021):







A4 display energy and water bars:



	Prewash	Jet18	Quick30	Eco	Eco 5,4lt	Sup 50	Daily	Dual Pro W	A./Delicate	A./Normal	A./Intensive	Steam
Energy	1	2	2	3	4	5	5	5	4	5	8	7
Water	1	2	4	3	2	4	5	5	6	7	8	7

Models Without Salt Tank: A15 AUS, A21 AUS, A23 AUS

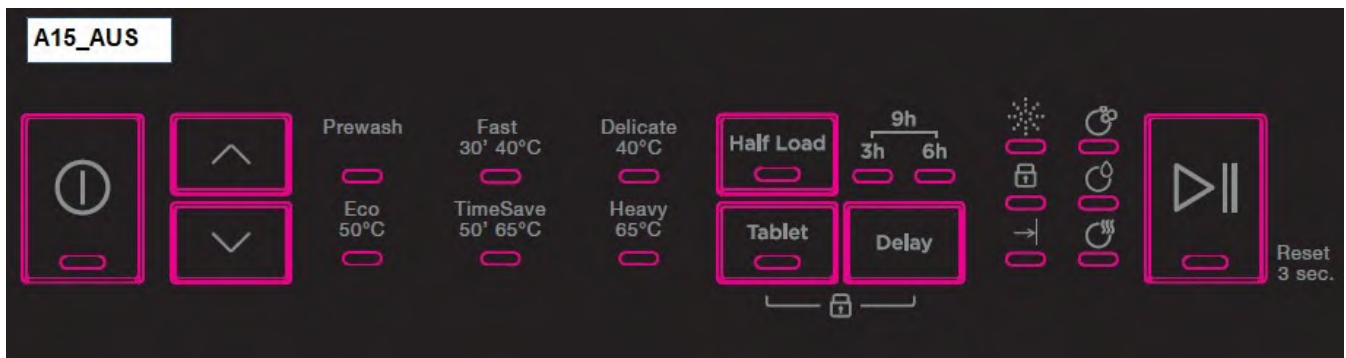

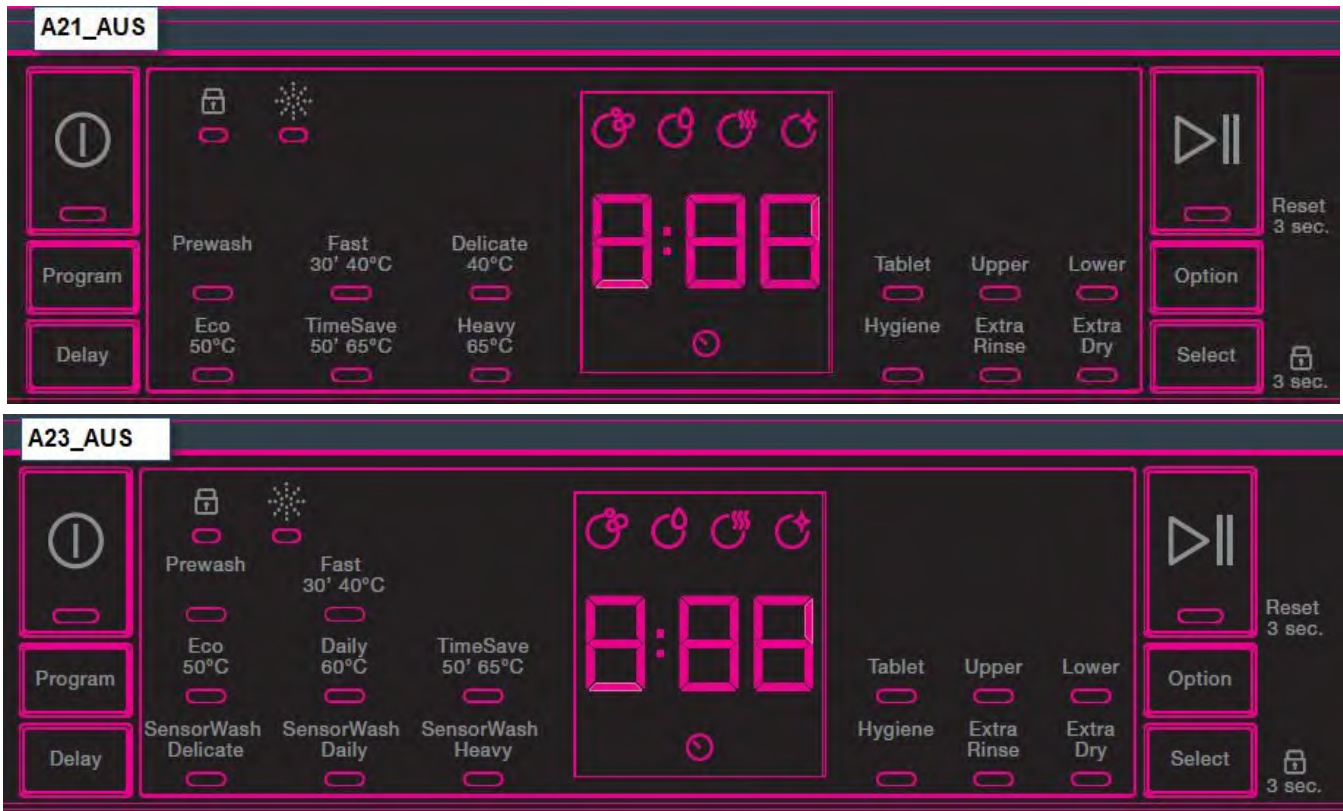

1.2. Washing Programmes

WASHING PROGRAM CROSS TABLE

MODEL	PREWASH	JETWASH 14'	QUICK 30'	ECO 50 °C	Eco 5.4 lt	Save+ 5.4 lt SUPER 50' 65 °C	DELICATE	INTENSIVE 65°C	AUTO	DAILY 60°C	Easy Care	DUAL PRO WASH 60°C	HYGIENE 70°C	AUTO DELICATE 30°C -50°C	Smart 30°C -	AUTO NORMAL 50°C -60°C	Smart 50°C -	AUTO INTENSIVE 60°C -70°C	Smart 60°C -	STEAM WASH	UVC "WaterFree"
A11-A1A				X				X													
A12-A1B				X		X		X													
A13-A1C			X	X		X		X													
A14-A1D			X	X		X		X					X								
A15-A1E	X		X	X		X		X					X								
A15_AUS	X		X	X		X	X	X													
A21	X		X	X		X	X	X	X												
A21_AUS	X		X	X		X	X	X	X												

A22	X		X	X		X	X	X	X	X							
A23	X		X	X		X				X		X		X			
A23_AUS	X		X	X		X				X		X		X			
A24		X	X	X		X				X		X		X			
A25		X	X	X	X	X				X		X				X	
A26		X	X	X		X				X		X		X		X	

A27																	
A28																	
A29																	
A31	X	X	X	X		X										X	
A32	X	X	X	X		X					X		X		X		
A33		X	X	X		X				X						X	
A34		X	X	X		X				X		X		X		X	
A35		X	X	X	X	X				X		X				X	
A36		X	X	X		X				X		X		X		X	
A37																	
A38																	
A39																	
A3Y		X	X	X	X	X				X		X				X	
A3Y_UVCT			X	X	X	X				X		X				X	X
A41	X		X	X		X				X						X	
A42	X	X	X	X		X				X						X	
A43	X	X	X	X		X			X	X		X		X		X	
A44	X	X	X	X		X			X	X		X		X		X	
A45	X	X	X	X	X	X				X		X		X			X
A46																	
A47																	
A48																	

A49																		
A4Y	X	X	X	X	X	X					X		X	X			X	
A4Y_UV CT																		X

PROGRAMME SEQUENCES

Note: The program names in this section must be used in the Veezy application.

Programme Number	A11-A1A	A12-A1B	A13-A1C	A14-A1D	A15-A1E	A15_AUS	A16-A1F	A17-A1G
P1	Eco 50°C	Eco 50°C	Quick 30' 40°C	Quick 30' 40°C	Prewash	Prewash	Jet wash 14'	Jet wash 14'
P2	Intensive 65°C	Super 50' 65°C	Eco 50°C	Eco 50°C	Quick 30' 40°C	Quick 30' 40°C	Quick 30' 40°C	Quick 30' 40°C
P3	-	Intensive 65°C	Super 50' 65°C	Super 50' 65°C	Eco 50°C	Delicate	Eco 50°C	Delicate 40°C
P4	-	-	Intensive 65°C	Intensive 65°C	Super 50' 65°C	Eco 50°C	Super 50' 65°C	Eco 50°C
P5	-	-	-	Hygiene 70°C	Intensive 65°C	Super 50' 65°C	Intensive 65°C	Super 50' 65°C
P6	-	-	-	-	Hygiene 70°C	Intensive 65°C	Hygiene 70°C	Intensive 65°C
P7	-	-	-	-	-	-	Steam Wash	Hygiene 70°C
P8	-	-	-	-	-	-	-	Steam Wash

Programme Number	A1A_ELS	A1B_ELS	A1C_ELS	A1D_ELS	A1E_ELS
P1	Eco 50°C	Eco 50°C	Quick 30' 40°C	Quick 30' 40°C	Prewash
P2	Intensive 65°C	Intensive 65°C	Eco 50°C	Eco 50°C	Quick 30' 40°C
P3	-	Super 50' 65°C	Intensive 65°C	Intensive 65°C	Eco 50°C
P4	-	-	Super 50' 65°C	Super 50' 65°C	Intensive 65°C
P5	-	-	-	Hygiene 70°C	Super 50' 65°C
P6	-	-	-	-	Hygiene 70°C

Programme Number	A21 A21_AUS	A22	A23 A23_AUS	A24	A25	A26_ELS	A27_ELS	A28_ELS	A29_ELS
P1	Prewash	Prewash	Prewash	Jetwash 14'	Jetwash 14'	Jetwash 14'	Jetwash 14'	Jetwash 14'	Jetwash 14'
P2	Quick 30' 40°C	Quick 30' 40°C	Quick 30' 40°C	Quick 30' 40°C	Quick 30' 40°C	Quick 30' 40°C	Quick 30' 40°C	Quick 30' 40°C	Quick 30' 40°C
P3	Delicate 40°C	Delicate 40°C	Eco 50°C	Eco 50°C	Eco 50°C	Eco 50°C	Eco 50°C	Eco 50°C	Eco 50°C
P4	Eco 50°C	Eco 50°C	Easy Care 60°C	Dual Pro Wash 60°C	Save+ 5.4 lt	Smart 50°C - 70°C	Smart 50°C - 70°C	Smart 30°C - 50°C	Smart 30°C - 50°C
P5	Super 50' 65°C	Easy Care 60°C	Super 50' 65°C	Super 50' 65°C	Dual Pro Wash 60°C	Dual Pro Wash 60°C	Dual Pro Wash 60°C	Smart 50°C - 70°C (Akışı Smart 60°C - 70°C ile aynı)	Smart 50°C - 60°C

P6	Intensive 65°C	Super 50' 65°C	Smart 30°C - 50°C	Smart 30°C - 50°C	Super 50' 65°C	Super 50' 65°C	Super 50' 65°C	Dual Pro Wash 60°C	Smart 60° C - 70°C
P7	-	Intensive 65°C	Smart 50°C - 60°C	Smart 50° C - 60°C	Smart 30°C - 50°C		Steam Wash	Super 50' 65°C	Dual Pro Wash 60°C
P8	-	-	Smart 60°C - 70°C	Smart 60° C - 70°C	Smart 50° C - 70°C (Akışı Smart 60°C - 70°C ile aynı)			Steam Wash	Super 50' 65°C
P9									Steam Wash

Programme Number	A26	A27	A28	A29
P1	Mini 14'	Mini 14'	Mini 14'	Mini 14'
P2	Quick 30' 40°C	Quick 30' 40°C	Quick 30' 40°C	Quick 30' 40°C
P3	Eco 50°C	Eco 50°C	Eco 50°C	Eco 50°C
P4	Dual Pro Wash 60°C	Dual Pro Wash 60°C	Dual Pro Wash 60°C	Dual Pro Wash 60°C
P5	Super 50' 65°C	Super 50' 65°C	Super 50' 65°C	Super 50' 65°C
P6	Smart 50°C - 70°C	Smart 50°C - 70°C	Smart 30°C - 50°C	Smart 30°C - 50°C
P7		Steam Wash	Smart 50°C - 70°C	Smart 50°C - 60°C
P8			Steam Wash	Smart 60°C - 70°C
P9				Steam Wash

Programme Number	A31	A32	A33	A34	A35	A36
P1	Prewash	Prewash	Jetwash 14'	Jetwash 14'	Jetwash 14'	Jetwash 14'
P2	Jetwash 14'	Jetwash 14'	Quick 30' 40°C	Quick 30' 40°C	Quick 30' 40°C	Quick 30' 40°C
P3	Quick 30' 40°C	Quick 30' 40°C	Eco 50°C	Eco 50°C	Eco 50°C	Eco 50°C
P4	Eco 50°C	Eco 50°C	Dual Pro Wash 60°C	Dual Pro Wash 60°C	Save+ 5.4 lt	Dual Pro Wash 60°C
P5	Super 50' 65°C	Super 50' 65°C	Super 50' 65°C	Super 50' 65°C	Dual Pro Wash 60°C	Super 50' 65°C
P6	Smart 60°C - 70°C	Smart 30°C - 50°C	Smart 60°C - 70°C	Smart 30°C - 50°C	Super 50' 65°C	Smart 30°C - 50°C
P7	-	Smart 50°C - 60°C	-	Smart 50°C - 60°C	Smart 30°C - 50°C	Smart 50°C - 60°C
P8	-	Smart 60°C - 70°C	-	Smart 60°C - 70°C	Smart 50°C - 70°C (Akışı Smart 60°C - 70°C ile aynı)	Smart 60°C - 70°C



































Programme Number	A36	A37	A38	A39	A3Y	A3Y_UVCT
P1	Mini 14'	Mini 14'	Mini 14'	Mini 14'	Jetwash 14'	WaterFree 20'
P2	Quick 30' 40°C	Quick 30' 40°C	Quick 30' 40°C	Quick 30' 40°C	Quick 30' 40°C	Quick 30' 40°C
P3	Eco 50°C	Eco 50°C	Eco 50°C	Eco 50°C	Eco 50°C	Eco 50°C
P4	Dual Pro Wash 60°C	Dual Pro Wash 60°C	Dual Pro Wash 60°C	Dual Pro Wash 60°C	Save+ 5.4 lt	Save+ 5.4 lt
P5	Super 50' 65°C	Super 50' 65°C	Super 50' 65°C	Super 50' 65°C	Dual Pro Wash 60°C	Dual Pro Wash 60°C





































P6	Smart 50°C - 70°C	Smart 50°C - 70°C	Smart 30°C - 50°C	Smart 30°C - 50°C	Super 50' 65°C	Super 50' 65°C
P7		Steam Wash	Smart 50°C - 70°C	Smart 50°C - 60°C	Smart 30°C - 50°C	Smart 30°C - 50°C
P8			Steam Wash	Smart 60°C - 70°C	Smart 50°C - 70°C	Smart 50°C - 70°C
P9				Steam Wash		































Programme Number	A41	A42	A43	A44	A45
P1	Prewash	Prewash	Prewash	Prewash	Prewash
P2	Quick 30' 40°C	Jetwash 14'	Jetwash 14'	Jetwash 14'	Jetwash 14'
P3	Eco 50°C	Quick 30' 40°C	Quick 30' 40°C	Quick 30' 40°C	Quick 30' 40°C
P4	Dual Pro Wash 60°C	Eco 50°C	Eco 50°C	Eco 50°C	Eco 50°C
P5	Super 50' 65°C	Dual Pro Wash 60°C	Easy Care 60°C	Easy Care 60°C	Save+ 5.4 lt
P6	Smart 60°C - 70°C	Super 50' 65°C	Dual Pro Wash 60°C	Dual Pro Wash 60°C	Dual Pro Wash 60°C
P7	-	Smart 60°C - 70°C	Super 50' 65°C	Super 50' 65°C	Super 50' 65°C
P8	-	-	Smart 30°C - 50°C	Smart 30°C - 50°C	Smart 30°C - 50°C
P9	-	-	Smart 50°C - 60°C	Smart 50°C - 60°C	Smart 50°C - 60°C
P10	-	-	Smart 60°C - 70°C	Smart 60°C - 70°C	Steam Wash





































Programme Number	A46	A47	A48	A49	A4Y	A4Y_UVCT
P1	Mini 14'	Mini 14'	Mini 14'	Mini 14'	Prewash	WaterFree 20'
P2	Quick 30' 40°C	Quick 30' 40°C	Quick 30' 40°C	Quick 30' 40°C	Jetwash 14'	Jetwash 14'
P3	Eco 50°C	Eco 50°C	Eco 50°C	Eco 50°C	Quick 30' 40°C	Quick 30' 40°C
P4	Dual Pro Wash 60°C	Dual Pro Wash 60°C	Dual Pro Wash 60°C	Dual Pro Wash 60°C	Eco 50°C	Eco 50°C
P5	Super 50' 65°C	Super 50' 65°C	Super 50' 65°C	Super 50' 65°C	Save+ 5.4 lt	Save+ 5.4 lt
P6	Smart 50°C - 70°C	Smart 50°C - 70°C	Smart 30°C - 50°C	Smart 30°C - 50°C	Dual Pro Wash 60°C	Dual Pro Wash 60°C
P7		Steam Wash	Smart 50°C - 70°C	Smart 50°C - 60°C	Super 50' 65°C	Super 50' 65°C
P8			Steam Wash	Smart 60°C - 70°C	Smart 30°C - 50°C	Smart 30°C - 50°C
P9				Steam Wash	Smart 50°C - 60°C	Smart 50°C - 60°C
P10					Steam Wash	Steam Wash























2.1 Sharp Program Names and Icons:





Prg. No:	A11	A12	A13	A14	A15	A16	A17
	A1A	A1B	A1C	A1D	A1E	A1F	A1G
P1	Eco 50°C 	Eco 50°C 	Quick 30' 40°C 	Quick 30' 40°C 	Prewash 	Quick Wash 14' 	Quick Wash 14' 
P2	Intensive 65°C / Auto 	Express 50' 65°C 	Eco 50°C 	Eco 50°C 	Quick 30' 40°C 	Quick 30' 40°C 	Quick 30' 40°C 
P3		Intensive 65°C / Auto 	Express 50' 65°C 	Express 50' 65°C 	Eco 50°C 	Eco 50°C 	Delicate 40°C 
P4			Intensive 65°C / Auto 	Intensive 65°C / Auto 	Express 50' 65°C 	Express 50' 65°C 	Eco 50°C 
P5				Hygiene 70°C 	Intensive 65°C / Auto 	Intensive 65°C / Auto 	Express 50' 65°C 
P6					Hygiene 70°C 	Hygiene 70°C 	Intensive 65°C / Auto 
P7						Steam Wash 	Hygiene 70°C 
P8							Steam Wash 











































Prg. No:	A21	A22	A23	A24	A25
P1	Prewash 	Prewash 	Prewash 	Quick Wash 14' 	Quick Wash 14' 
P2	Quick 30' 40°C 	Quick 30' 40°C 	Quick 30' 40°C 	Quick 30' 40°C 	Quick 30' 40°C 
P3	Delicate 40°C 	Delicate 40°C 	Eco 50°C 	Eco 50°C 	Eco 50°C 
P4	Eco 50°C 	Eco 50°C 	Everyday 60°C 	Dual Pro Wash 60°C 	Watersaver 5.4lt 
P5	Express 50' 65°C 	Everyday 60°C 	Express 50' 65°C 	Express 50' 65°C 	Dual Pro Wash 60°C 
P6	Intensive 65°C / Auto 	Express 50' 65°C 	Auto 30°C-50°C 	Auto 30°C - 50°C 	Express 50' 65°C 
P7		Intensive 65°C / Auto 	Auto 50°C-60°C 	Auto 50°C - 60°C 	Auto 30°C - 50°C 
P8			Auto 60°C-70°C 	Auto 60°C-70°C 	Auto 50°C-70°C 

















































Prg. No:	A26	A27	A28	A29
P1	Quick Wash 14' 	Quick Wash 14' 	Quick Wash 14' 	Quick Wash 14' 
P2	Quick 30' 40°C 	Quick 30' 40°C 	Quick 30' 40°C 	Quick 30' 40°C 
P3	Eco 50°C 	Eco 50°C 	Eco 50°C 	Eco 50°C 
P4	Dual Pro Wash 60°C 	Dual Pro Wash 60°C 	Dual Pro Wash 60°C 	Dual Pro Wash 60°C 
P5	Express 50' 65°C 	Express 50' 65°C 	Express 50' 65°C 	Express 50' 65°C 
P6	Auto 50°C-70°C 	Auto 50°C-70°C 	Auto 30°C - 50°C 	Auto 30°C-50°C 
P7		Steam Wash 	Auto 50°C-70°C 	Auto 50°C-60°C 
P8			Steam Wash 	Auto 60°C-70°C 
P9				Steam Wash 

Prg. No:	A31	A32	A33	A34	A35
P1	Prewash 	Prewash 	Quick Wash 14' 	Quick Wash 14' 	Quick Wash 14' 
P2	Quick Wash 14' 	Quick Wash 14' 	Quick 30' 40°C 	Quick 30' 40°C 	Quick 30' 40°C 
P3	Quick 30' 40°C 	Quick 30' 40°C 	Eco 50°C 	Eco 50°C 	Eco 50°C 
P4	Eco 50°C 	Eco 50°C 	Dual Pro Wash 60°C 	Dual Pro Wash 60°C 	Watersaver 5.4lt 
P5	Express 50' 65°C 	Express 50' 65°C 	Express 50' 65°C 	Express 50' 65°C 	Dual Pro Wash 60°C 
P6	Auto 60°C-70°C 	Auto 30°C-50°C 	Auto 60°C-70°C 	Auto 30°C-50°C 	Express 50' 65°C 
P7		Auto 50°C-60°C 		Auto 50°C-60°C 	Auto 30°C - 50°C 
P8		Auto 60°C-70°C 		Auto 60°C-70°C 	Auto 50°C-70°C 

Prg. No:	A36	A37	A38	A39	A3Y	A3Y_UVCT
P1	Quick Wash 14' 	Quick Wash 14' 	Quick Wash 14' 	Quick Wash 14' 	Quick Wash 14' 	WaterFree 20'
P2	Quick 30' 40°C 	Quick 30' 40°C 	Quick 30' 40°C 	Quick 30' 40°C 	Quick 30' 40°C 	Quick 30' 40°C 
P3	Eco 50°C 	Eco 50°C 	Eco 50°C 	Eco 50°C 	Eco 50°C 	Eco 50°C 
P4	Dual Pro Wash 60°C 	Dual Pro Wash 60°C 	Dual Pro Wash 60°C 	Dual Pro Wash 60°C 	Watersaver 5.4lt 	Watersaver 5.4lt 

P5	Express 50' 65°C 	Express 50' 65°C 	Express 50' 65°C 	Express 50' 65°C 	Express 50' 65°C 	Express 50' 65°C 
P6	Auto 50°C-70°C 	Auto 50°C-70°C 	Auto 30°C - 50°C 	Auto 30°C-50°C 	Express 50' 65°C 	Express 50' 65°C 
P7		Steam Wash 	Auto 50°C-70°C 	Auto 50°C-60°C 	Auto 30°C - 50°C 	Auto 30°C - 50°C 
P8			Steam Wash 	Auto 60°C-70°C 	Auto 50°C-70°C 	Auto 50°C-70°C 
P9				Steam Wash 		

Prg. No:	A41	A42	A43	A44	A45
P1	Prewash 	Prewash 	Prewash 	Prewash 	Prewash 
P2	Quick 30' 40°C 	Quick Wash 14' 	Quick Wash 14' 	Quick Wash 14' 	Quick Wash 14' 
P3	Eco 50°C 	Quick 30' 40°C 	Quick 30' 40°C 	Quick 30' 40°C 	Quick 30' 40°C 
P4	Dual Pro Wash 60°C 	Eco 50°C 	Eco 50°C 	Eco 50°C 	Eco 50°C 
P5	Express 50' 65°C 	Dual Pro Wash 60°C 	Everyday 60°C 	Everyday 60°C 	Watersaver 5.4lt 
P6	Auto 60°C-70°C 	Express 50' 65°C 	Dual Pro Wash 60°C 	Dual Pro Wash 60°C 	Dual Pro Wash 60°C 
P7		Auto 60°C-70°C 	Express 50' 65°C 	Express 50' 65°C 	Express 50' 65°C 
P8			Auto 30°C-50°C 	Auto 30°C-50°C 	Auto 30°C-50°C 
P9			Auto 50°C-60°C 	Auto 50°C-60°C 	Auto 50°C-60°C 
P10			Auto 60°C-70°C 	Auto 60°C-70°C 	Steam Wash 

Prg. No:	A46	A47	A48	A49	A4Y	A4Y_UVCT
P1	Quick Wash 14' 	Quick Wash 14' 	Quick Wash 14' 	Quick Wash 14' 	Prewash 	WaterFree 20'
P2	Quick 30' 40°C 	Quick 30' 40°C 	Quick 30' 40°C 	Quick 30' 40°C 	Quick Wash 14' 	Quick Wash 14' 
P3	Eco 50°C 	Eco 50°C 	Eco 50°C 	Eco 50°C 	Quick 30' 40°C 	Quick 30' 40°C 
P4	Dual Pro Wash 60°C 	Dual Pro Wash 60°C 	Dual Pro Wash 60°C 	Dual Pro Wash 60°C 	Eco 50°C 	Eco 50°C 
P5	Express 50' 65°C 	Express 50' 65°C 	Express 50' 65°C 	Express 50' 65°C 	Watersaver 5.4lt 	Watersaver 5.4lt 
P6	Auto 50°C-70°C 	Auto 50°C-70°C 	Auto 30°C - 50°C 	Auto 30°C-50°C 	Dual Pro Wash 60°C 	Dual Pro Wash 60°C 
P7		Steam Wash 	Auto 50°C-70°C 	Auto 50°C-60°C 	Express 50' 65°C 	Express 50' 65°C 
P8			Steam Wash 	Auto 60°C-70°C 	Auto 30°C - 50°C 	Auto 30°C - 50°C 
P9				Steam Wash 	Auto 50°C-70°C 	Auto 50°C-70°C 
P10					Steam Wash 	Steam Wash 

2.2 Program Icons:

Icon Set				
	Icon Definition	Control Panel Serigraphy	Led Display Interface	Mobile App Interface
PROGRAMLAR	Ön Yıkama Prewash			
	Jet Yıkama Jet Wash			
	Hızlı 30dk. 40°C Quick 30' 40°C			
	Eko Eco			
	Süper 50 dk. 65°C Super 50' 65°C			
	Süper 55 dk. 60°C Super 55' 60°C			
	Cam ve Bardak Yıkama Delicate 40°C			
	Akıllı 55°C Clean+ 55°C			
	Pratik 60°C Easy Care 60°C			
	Alt Üst Hızlı Yıkama 60°C Dual ProWash 60°C			
	Hijyen 60°C Hygiene 60°C			
	Hijyen 70°C Hygiene 70°C			
	Yoğun 65°C Intensive 65°C			
	Yoğun 70°C Intensive 70°C			
Oto Auto				

Oto Hassas 30°C-50°C /Camve Bardak Yıkama Smart 30°C-50°C			
Oto Akıllı 50°C-60° Oto 50°C-60° Smart 50°C-60°C			
Oto Yoğun 50°-70°C Oto 50°-70°C Smart 50°C-70°C			
Oto Yoğun 60°-70°C Oto 60°-70°C Smart 60°C-70°C			
Ekstra Yoğun 70° Extra Intensive 70°C			
Ekstra Hijyen 70°C Extra Hygiene 70°C			
Favori Favourite			
Buharla Yıkama Steam Wash			
Tasarruf 5.4lt Save+ 5.4lt			

1.3. WASHING SPECIFICATIONS AND PROGRAMS

SELECTING AND STARTING PROGRAM AT POWER ON(BEFORE PROGRAM STARTS)

- When the machine is energized, all led + digits should stay lit (A1,A2,A3,A4) until the program information (ready position or any other status, remaining step) is displayed on the display.

When the dishwasher is switched on,

For models w/o display;

COMMANDS	On/Off	Start/Stop	Wash	Dry	End
Switch on	ON	ON	OFF	OFF	OFF
Select program	ON	ON	OFF	OFF	OFF
Pressure of Start/Stop button	ON	OFF	ON	OFF	OFF

When user selects a program, related program led is ON. After pressing Start/Stop button, related program and Wash led are ON.

Note: When user always presses up button, first program follows last program. (ex: Program 1-2-3-4-5-6-1-2-...) When user always presses down button, last program follows first program. (ex: Program 6-5-4-3-2-1-6-5-4-...)

For models w/ display;

-the duration of the selected cycle is shown on the display.

COMMANDS	On/Off	Start/Stop	Wash	Rinse	Dry	End
Switch on	ON	ON	OFF	OFF	OFF	OFF
Select program	ON	ON	OFF	OFF	OFF	OFF
Pressure of Start/Stop button	ON	OFF	ON	OFF	OFF	OFF

- Default program is "Eco program".

- When the dishwasher is powered off and on again in selection situation, the last executed program and options are not visualized on screen anymore. Every time machine is energized, Eco program is set as default.

OPENING AND CLOSING DOOR(BEFORE PROGRAM STARTS)

For models w/o display;

COMMANDS	On/Off	Start/Stop	Wash	Dry	End
Door open	ON	ON	OFF	OFF	OFF
Door closed	ON	ON	OFF	OFF	OFF

For models w/ display;

COMMANDS	On/Off	Start/Stop	Wash	Rinse	Dry	End
Door open	ON	ON	OFF	OFF	OFF	OFF
Door closed	ON	ON	OFF	OFF	OFF	OFF

OPENING AND CLOSING DOOR DURING PROGRAM(NOT IN DRY STEPS)

During the program if the door is opened and re-closed without any modifications on the program button and without the pressure of Start/Stop button, the program continues. Washing program re-starts after 8" if the measured temperature is equal or more than 45°C.

For models w/o display;

COMMANDS	On/Off	Start/Stop	Wash	Dry	End
Door open	ON	Blink	ON	OFF	OFF
Door closed	ON	OFF	ON	OFF	OFF

*When the door is opened, Washled is ON together with the blinking Start/Stop led.

For models w/ display;

COMMANDS	On/Off	Start/Stop	Wash	Rinse	Dry	End
Door open	ON	Blink	ON/OFF*	ON/OFF*	OFF	OFF
Door closed	ON	OFF	ON/OFF*	ON/OFF*	OFF	OFF

*When the door is opened, related washing step led is ON together with the blinking Start/Stop led.

OPENING AND CLOSING DOOR DURING PROGRAM(IN DRY STEPS)

For models w/o display;

During dry step: if the door is opened and re-closed, the program is ended.

COMMANDS	On/Off	Start/Stop	Wash	Dry	End
Door open	ON	Blink	OFF	ON	OFF
Door closed	ON	OFF	OFF	OFF	ON

*When the door is opened, Dry led is ON together with the blinking Start/Stop led.

When the door is closed, program ends and End led is ON.

- Next, if user presses program or Start/Stop or delay button, machine is in standby position(last executed programme led and Start/Stop led are ON)
- Then, if user presses Start/Stop button, wash led is ON.

For models w/ display;

During dry step: if the door is opened and re-closed, the program is continued.

COMMANDS	On/Off	Start/Stop	Wash	Rinse	Dry	End
Door open	ON	Blink	OFF	OFF	ON	OFF
Door closed	ON	OFF	OFF	OFF	ON	OFF

OPENING AND CLOSING DOOR DURING PROGRAM(IN REGENERATION FIRST STEP)

During regeneration and resin washing step: if the door is opened and re-closed, the program continues.

For models w/o display;

COMMANDS	On/Off	Start/Stop	Wash	Dry	End
Door open	ON	Blink	OFF	ON	OFF
Door closed	ON	OFF	OFF	ON	OFF

*When the door is opened, Dry led is ON together with the blinking Start/Stop led.

When the door is closed, Dry led is ON.

For models w/ display;

COMMANDS	On/Off	Start/Stop	Wash	Rinse	Dry	End
Door open	ON	Blink	OFF	OFF	ON	OFF
Door closed	ON	OFF	OFF	OFF	ON	OFF

OPENING AND CLOSING DOOR DURING PROGRAM(IN REGENERATION SECOND STEP)

During regeneration and resin washing step: if the door is opened and re-closed, the program is ended.

For models w/o display;

COMMANDS	On/Off	Start/Stop	Wash	Dry	End
Door open	ON	Blink	OFF	ON	OFF
Door closed	ON	OFF	OFF	OFF	ON

*When the door is opened, Dry led is ON together with the blinking Start/Stop led.

When the door is closed, the program ends. Machine is in standby position(last executed programme led and Start/Stop led are ON)

For models w/ display;

COMMANDS	On/Off	Start/Stop	Wash	Rinse	Dry	End
Door open	ON	Blink	OFF	OFF	ON	OFF
Door closed	ON	OFF	OFF	OFF	OFF	ON

When the door is opened and re-closed, program ends and only end led , on/off led, salt/rinse aid lack leds(if salt/rinse aid tanks are empty) are on.

1.4. SELECTING AND STARTING PROGRAM WHEN DOOR IS OPENED(BEFORE PROGRAM STARTS)

For models w/o display;

COMMANDS	On/Off	Start/Stop	Wash	Dry	End
Switch on	ON	ON	OFF	OFF	OFF
Door open	ON	ON	OFF	OFF	OFF
Select program	ON	ON	OFF	OFF	OFF
Pressure of Start/Stop button	ON	Blink*	ON	OFF	OFF
Door closed	ON	OFF	ON	OFF	OFF

*If user presses Start/Stop button, Start/Stop led blinks and also related program led(s) is ON. After closing the door, Wash led is ON and selected program starts.

For models w/ display;

COMMANDS	On/Off	Start/Stop	Wash	Rinse	Dry	End
Switch on	ON	ON	OFF	OFF	OFF	OFF
Door open	ON	ON	OFF	OFF	OFF	OFF
Select program	ON	ON	OFF	OFF	OFF	OFF
Pressure of Start/Stop button	ON	Blink*	ON	OFF	OFF	OFF
Door closed	ON	OFF	ON	OFF	OFF	OFF

If user selects a program when the door is open, related program duration is seen on the display. Then, if user presses Start/Stop button, duration of the selected program led blinks. After closing the door, Wash led is ON and selected program starts.

1.5. TERMINATION OF A PROGRAM(END OF PROGRAM)

For models w/o display;

COMMANDS	On/Off	Start/Stop	Wash	Dry	End
End of program	ON	OFF	OFF	OFF	ON
Door open	ON	OFF	OFF	OFF	ON
Door closed	ON	ON	OFF	OFF	OFF

When the door is closed, last executed program led and Start/stop led are ON. Namely, Machine is in standby position.

Note: For models w/o display; after program ends, the last executed program led and end led will be on.

For models w/ display;

COMMANDS	On/Off	Start/Stop	Wash	Rinse	Dry	End	Digit
End of program	ON	OFF	OFF	OFF	OFF	ON	OFF
Door open	ON	OFF	OFF	OFF	OFF	ON	OFF
Door closed	ON	ON	OFF	OFF	OFF	OFF	OFF

At the end of program, and only end led, on/off led, salt/rinse aid lack leds(if salt/rinse aid tanks are empty) are on. If there is no user intervention during 15 minutes after program has ended, machine turns off completely.

1.6. 9 CANCELLING OF A PROGRAM(DURING PROGRAM)

For models w/o display;

COMMANDS	On/Off	Start/Stop	Wash	Dry	End
Pressure of Start/Stop button 3"	ON	ON	OFF	OFF	Blink
End of program	ON	OFF	OFF	OFF	ON

While pressing the Start/Stop button for 3", End led blinks. After cancelling is finished, "End Led" is ON.

For models w/ display;

COMMANDS	On/Off	Start/Stop	Wash	Rinse	Dry	End	Digit
Pressure of Start/Stop button 3"	ON	ON	OFF	OFF	OFF	Blink	"0:01"
End of program	ON	OFF	OFF	OFF	OFF	ON	OFF

For A1 without digit models

- Display shows "0:01" during cancelation process. End led blinks. When cancellation is paused, S/P led blinks. Display is off at the end of the cancelation process and and only end led , on/off led, salt/rinse aid lack leds(if salt/rinse aid tanks are empty) are on.

For A1 with digit, A2, A3, A4 models;

- Display shows "0:01" during cancelation process. Dry led is on. When cancellation is paused, Dry led blinks. Display is off at the end of the cancelation process and and only end led , on/off led, salt/rinse aid lack leds(if salt/rinse aid tanks are empty) are on. (For A1 with digit and A2 models, this is valid from 01.12.2020).

If there is no user intervention during 15 minutes after program has cancelled, machine turns off completely For both models with and without display:

If cancelling operation is paused, S/P led and end led blinks together.

1.7. IF USER PRESSES ANY BUTTON(AT THE END OF PROGRAM)

For models w/o display;

COMMANDS	On/Off	Start/Stop	Wash	Dry	End
End of program	ON	OFF	OFF	OFF	ON
Selection of new program or pressed option	ON	ON	OFF	OFF	OFF
Pressure of Start/Stop button	ON	OFF	ON	OFF	OFF

-When user selects a program at the end of program, related program led and Start/Stop led are ON. If selected, related option led(s) is ON.

After pressing Start/Stop button Wash led is ON. If selected, related option led(s) is ON.

For models w/ display;

COMMANDS	On/Off	Start/Stop	Wash	Rinse	Dry	End	Digit
End of program	ON	OFF	OFF	OFF	OFF	ON	OFF
Selection of new program or pressed option	ON	ON	OFF	OFF	OFF	OFF	Duration of new program is shown
Pressure of Start/Stop button	ON	OFF	ON	OFF	OFF	OFF	Duration of new program

When user selects a program at the end of program, related program duration is shown on the display. If selected, related option led is ON.

After pressing Start/Stop button, program starts and Wash led is ON. If selected, related option led(s) is ON.

1.8. MODIFICATION OF A PROGRAM WITHOUT RESET

The program continues with the flow program but with the parameters (temperature, times) of the new program. In heating step: If temperature is over than the new desired temperature, cut off heating step and go on with the next step with new parameters.

If temperature is lower than the new desired temperature heat up water to the desired temperature level.

In washing step: If the washing duration is over than the washing duration of new program, cut off washing step and go on with next step of new program.

If the washing duration is lower than the washing duration of new program, go on with washing step. When new program is selected, display duration is changed to same step of new program.

For models w/o display;

COMMANDS	On/Off	Start/Stop	Wash	Dry	End
Washing cycle is in progress	ON	OFF	ON/OFF	ON/OFF	OFF
Pressure of Start/Stop button	ON	Blink	ON/OFF	ON/OFF	OFF
Select new program	ON	Blink	ON/OFF	ON/OFF	OFF
Pressure of Start/Stop button	ON	OFF	ON/OFF*	ON/OFF*	OFF

If user selects new program, related new program led is ON.

*Program continues with the new parameters and related washing led is ON.

For models w/ display;

COMMANDS	On/Off	Start/Stop	Wash	Rinse	Dry	End	Digit
Washing cycle is in progress	ON	OFF	ON/OFF	ON/OFF	ON/OFF	OFF	Duration of program
Pressure of Start/Stop button	ON	Blink	ON/OFF	ON/OFF	ON/OFF	OFF	Duration of program
Select new program	ON	Blink	ON/OFF	ON/OFF	ON/OFF	OFF	duration of new program
Pressure of Start/Stop button	ON	OFF	ON/OFF*	ON/OFF*	ON/OFF*	OFF	Duration of new program

*If user presses Start/Stop button, program continues with the new parameters and related washing led is ON

1.9. MODIFICATION OF A PROGRAM WITH RESET

For models w/o display;

COMMANDS	On/Off	Start/Stop	Wash	Dry	End
Washing cycle is in progress	ON	OFF	ON/OFF	ON/OFF	OFF
Pressure of Start/Stop button 3"	ON	OFF	OFF	OFF	Blink
Drain of water	ON	OFF	OFF	ON	Blink
End of Drain	ON	OFF	OFF	OFF	ON*
Select new program	ON	ON	OFF	OFF	OFF

*During the cancellation process End led blinks. After cancelling is finished, and only end led, on/off led, salt/rinse aid lack leds(if salt/rinse aid tanks are empty) are on.

After the cancellation process, if user selects new program, related program led is ON.

For models w/ display;

COMMANDS	On/Off	Start/Stop	Wash	Rinse	Dry	End	Digit
----------	--------	------------	------	-------	-----	-----	-------

Washing cycle is in progress	ON	OFF	ON/OFF	ON/OFF	ON/OFF	OFF	Duration of program
Pressure of Start/Stop button 3"	ON	OFF	OFF	OFF	OFF	Blinks	Duration of program
Drain of water	ON	OFF	OFF	OFF	ON	Blinks	0:01
End of Drain	ON	OFF	OFF	OFF	OFF	ON	OFF
Select new program	ON	ON	OFF	OFF	OFF	OFF	duration of new program

- Display shows "0:01" during reset process.

Display is off and only end led, on/off led, salt/rinse aid lack leds(if salt/rinse aid tanks are empty) are on at the end of the reset process

1.10. SWITCH OFF THE MACHINE DURING PROGRAM AND BEFORE STARTING PROGRAM

When user presses On/Off button in standby position, machine is changed to Power OFF position and all leds and display are OFF.

For models w/o display;

COMMANDS	On/Off	Start/Stop	Wash	Dry	End
Before starting program	ON	ON	OFF	OFF	OFF
Pressure of On/Off button	OFF	OFF	OFF	OFF	OFF

For models w/ display;

COMMANDS	On/Off	Start/Stop	Wash	Rinse	Dry	End	Digit
Before starting program	ON	ON	OFF	OFF	OFF	OFF	duration of program
Pressure of On/Off button	OFF	OFF	OFF	OFF	OFF	OFF	OFF

1.11. SWITCH OFF THE MACHINE DURING PROGRAM AND AFTER STARTING PROGRAM

When machine is changed to Power OFF position during program, all leds are OFF, display is OFF, Program is paused and all electrical components are stopped. After pressing On/Off button, machine is ON. Selecting any program does not affect the program flow of previously selected program. Therefore, previously selected program is resumed.

For models w/o display;

COMMANDS	On/Off	Start/Stop	Wash	Dry	End
Washing cycle is in progress	ON	OFF	ON/OFF	ON/OFF	OFF
Machine is "POWER OFF"	OFF	OFF	OFF	OFF	OFF
Machine is "POWER ON"	ON	OFF	ON/OFF	ON/OFF	OFF
Select new program*	ON	OFF	ON/OFF	ON/OFF	OFF
Pressure of Start/Stop button	ON	Blink	ON/OFF	ON/OFF	OFF
Pressure of Start/Stop button again	ON	OFF	ON/OFF	ON/OFF	OFF

*New program cannot be selected without pressing Start/Stop button.

For models w/ display;

COMMANDS	On/Off	Start/Stop	Wash	Rinse	Dry	End	Digit
Washing cycle is in progress	ON	OFF	ON/OFF	ON/OFF	ON/OFF	OFF	Duration of program
Machine is "POWER OFF"	OFF	OFF	OFF	OFF	OFF	OFF	OFF
Machine is "POWER ON"	ON	OFF	ON/OFF	ON/OFF	ON/OFF	OFF	Duration of program
Select new program*	ON	OFF	ON/OFF	ON/OFF	ON/OFF	OFF	Duration of new program
Pressure of Start/Stop button	ON	Blink	ON/OFF	ON/OFF	ON/OFF	OFF	Duration of new program
Pressure of Start/Stop button again	ON	OFF	ON/OFF	ON/OFF	ON/OFF	OFF	Duration of new program

*New program cannot be selected without pressing Start/Stop button.

Note: If the washing step is Dry before machine is powered off, program ends after machine is powered on.

1.12. CANCELLING OF A PROGRAM (DURING DELAY TIME)

For models w/o display;

COMMANDS	On/Off	Start/Stop	Wash	Dry	End	Selected indicators (delay timer)	Related program led
Pressure of Start/Stop button for 3"	ON	ON	OFF	OFF	Blink	ON	ON
End of program	ON	OFF	OFF	OFF	ON*	OFF	OFF

While pressing the Start/Stop button for 3", selected indicator led(3h, 6h or both 3h and 6h) is ON and related program led is ON.

*During the cancellation process End led blinks. After cancelling is finished, only end led, on/off led, salt/rinse aid lack leds(if salt/rinse aid tanks are empty) are on.

For models w/ display;

COMMANDS	On/Off	Start/Stop	Wash	Rinse	Dry	End	Digit
Pressure of Start/Stop button for 3"	ON	ON	OFF	OFF	OFF	Blinks	Delay duration
End of program	ON	OFF	OFF	OFF	OFF	ON*	OFF

While pressing the Start/Stop button for 3", delay duration is shown on display.

*During the cancellation process End led blinks and digit shows "0:01". At the end of cancelling, only end led, on/off led, salt/rinse aid lack leds (if salt/rinse aid tanks are empty) are on.

1.13. MODIFICATION OF A PROGRAM DURING DELAY TIME

- 1.13.1. **While delay timer is selected but not started or started and paused, if any program button is pressed, delay timer is cancelled and machine goes to ready state. (06.04.2020 tarihinde alınan karar itibarıyla geçerli).**

NOTE: When it is started as delayed, the delay icon becomes active.

For models w/o display;

COMMANDS	On/Off	Start/Stop	Selected indicators(delay timer)	Related program led
During delay time	ON	ON	ON	ON
Pressure of Start/Stop button	ON	Blink	ON	ON
Select new program	ON	Blink	OFF	New program led is ON
Pressure of Start/Stop button	ON	ON	ON	New program led is ON

New program starts with delay which is selected before.

For models w/ display;

COMMANDS	On/Off	Start/Stop	Delay	Digit
During delay time	ON	ON	ON	Delay duration
Pressure of Start/Stop button	ON	Blink	ON	1" Delay duration, 1" duration of program are shown alternately
Select new program	ON	Blink	OFF	duration of new program is shown
Pressure of Start/Stop button	ON	ON	ON	Delay duration

1.14. SWITCH OFF THE MACHINE DURING DELAY TIME

- While delay timer is active, If machine switch off and on by ON/OFF button, delay timer is cancelled and machine goes to ready position.
- If mains power off-on occurs (power cut); delay time resumes, does not start again, at this time Start/Stop led is ON and related delay led blinks twice.

Note: When user starts a programme with delay and activates child lock: if user switch off/on the machine or power cut occurs; both delay and child lock is active when machine is energized.

Note: When user selects delay time but does not presses Start/Stop button: if user switch off/on the machine, delay timer is cancelled and machine is on standby position.

For models w/o display;

COMMANDS	On/Off	Start/Stop	Selected indicators(delay timer)
During delay time	ON	ON	ON
Standby off	OFF	OFF	OFF
Standby on	ON	ON	OFF
Select new program	ON	ON	OFF
Pressure of Start/Stop button	ON	OFF	OFF

For models w/ display;

COMMANDS	On/Off	Start/Stop	Delay icon	Digit
During delay time	ON	ON	ON	Delay duration
Mains voltage is cut(Power off)	OFF	OFF	OFF	OFF
Mains voltage is back(Power on)	ON	ON	ON	Delay duration blinks twice and then resumes
Select new program	ON	ON	ON	Delay duration

Pressure of Start/Stop button	ON	OFF	ON	1" Delay duration, 1" duration of new program are shown alternately
-------------------------------	----	-----	----	---

1.15. BUZZER BEHAVIOURS

COMMANDS	Buzzer
Power On and Power Off	Short beep
Pressure of all buttons	cShort beep
During 3"count down	Short beep(in every second)
During canceling	Short beep(once in two seconds like T24 models)
End of program or cancellation	3*Long beep
Failure situation	2*Short beep+wait+2*Short beep+...
Invalid action	2*Short beep
Note: When machine is turned off automatically 15 minutes after no intervention, buzzer will not sound.	

Note:

For models with digit, during drying step:

if the machine is turned off and on, the program is ended,

if the program is paused and started or the door is opened and closed, the program continues where it remains.

For models without digit, during drying step:

if the machine is turned off and on or program is paused and started or the door is opened and closed the program is ended.

2. POWER FAIL

- **During a Delay Start:** At the power on, program consumes the remaining time.
- **During a Drain + Fill step:** At the power on the program restarts the step to the beginning (with the drain).
- **During a Wash step:** At the power on the program consumes the remaining time.
- **During a Heating step:** At the power on the program continues heating up to the desired temperature. The time out for the heating restart to the beginning (water could be cold again).
- **During a Dry step:** At the power on the program ends.
- **During the first two step of a salt regeneration cycle (60" REGVALVE = ON or 60" REGVALVE+DRAIN ON):** At the power on washing program will continue.
- **During the washing resin step at regeneration cycle:** At the power on the program ends.

It is possible that the power fail occurred when a regeneration cycle is requested. If it occurs:

- During the first two step of a salt regeneration cycle (60" REGVALVE = ON or 60" REGVALVE+DRAIN ON): at the power on washing program will continue.

- After the first two step of a salt regeneration cycle: at the power on the washing program will end and the resin wash will be performed at the beginning of the next washing cycle.

After a Power Fail washing program re-starts without any delay if temp. is less than 45 °C.

After a Power Fail washing program **wait 8"** before re-starts program if temp. is equal or more than 45 °C.

2.1. STANDBY ON/OFF – POWER ON/OFF

CL is active in standby position	Delay timer is active	CL+Delay timer are active
----------------------------------	-----------------------	---------------------------

Standby Off	Machine turns off	Machine turns off	Machine turns off
Standby On	CL is active (valid from 22.09.2020)	Delay timer is cancelled	CL+Delay timer are active
Power Off	Machine turns off	Machine turns off	Machine turns off
Power On	CL is cancelled	Delay timer is active	CL+Delay timer are active

Valid from 11.01.2021; in any mode (ready, run, pause, end, delay start), while the child lock is active,

- if the machine turns off and on again by on/off button, the child lock will stay active when the machine is energized. It will not be cancelled.
- if the mains power (220 V) is cut and machine is energized again, the child lock will be cancelled. (For the first phase of Vel sw's this behaviour is same with on/off button, this will be implemented on the 2nd phase)
- If the machine is turned off automatically 15 minutes after any usage, the child lock will stay active when the machine is energized.
- If the power cut occurs after machine is turned off by on/off button, the child lock will stay active when the machine is energized.

3. OPTIONS

5.1 OPTIONS & MODELS

-In case of Power fail during washing, options are stored in memory.

-When the machine is switched on again, the last selected options are active and washing must go on remaining.

-Due to Eco design requirements, each energized of the machine (by pressing ON/OFF) Eco program must be fixed as default, the options that are chosen before will be cancelled.

- In case of Power fail, options are stored in memory if it occurs in washing cycle.
- For models with display; At the end of the program, when drain step is performed, only the third digit that is on the right of display will be ON. (It shows only one "0"). Then, when the users push any button, display shows the total time of the program).

For all A models, each energized of the machine (by pressing ON/OFF), Eco program will be set as default setting. And the options that are chosen before (i.e: ~~child lock~~, delay option etc...) will be cancelled.

Valid from 11.01.2021; in any mode (ready, run, pause, end, delay start), while the child lock is active,

- if the machine turns off and on again by on/off button, the child lock will stay active when the machine is energized. It will not be cancelled.
- if the mains power (220 V) is cut and machine is energized again, the child lock will be cancelled. (For the first phase of Vel sw's this behaviour is same with on/off button, this will be implemented on the 2nd phase)
- If the machine is turned off automatically 15 minutes after any usage, the child lock will stay active when the machine is energized.
- If the power cut occurs after machine is turned off by on/off button, the child lock will stay active when the machine is energized.

Note:

For A2 60 and 45 cm models: after any program selection, if the Option button is pressed repeatedly, only the options that are compatible with that program will be on. The incompatible options are skipped. **(valid from 15.01.2021)**

For A3 60 and 45 cm models: when any program is selected, only the option icons that are compatible with that program will be half on. The incompatible options must be off. If the Option button is pressed repeatedly, only the options that are compatible with that program will be on. The incompatible options are skipped. **(valid from 15.01.2021)**

For A4 60 and 45 cm models: after any program selection, only the options that are compatible with that program will be half on. The incompatible options must be off. **(valid from 15.01.2021)**

For models w/o diverter;

Option	A11-A1A	A12-A1B	A13-A1C	A14-A1D	A15-A1E
Delay	X	X	X	X	X
Half load	X	X	X	X	X
Tablet	X	X	X	X	X





























For models w/o diverter w/ Autodoor;













Option	A11-A1A	A12-A1B	A13-A1C	A14-A1D	A15-A1E
Delay	X	X	X	X	X
Half load	X	X	X	X	X
Energy Save	X	X	X	X	X

For models w/ display-w/ diverter;

Option	A21	A22	A23	A24	A25	A26	A31	A33	A36	A41	A42	A44
							A32	A34			A43	A45
Delay	X	X	X	X	X	X	X	X	X	X	X	X
Half load(3 modes)	X	X	X	X	X	X	X	X	X	X	X	X
Tablet	X	X	X	X	X	X	X	X	X	X	X	X
Extra Hygiene	X	X	X	X	X	X	X	X	X	X	X	X
Extra Rinse	X	X	X	-	-	-	X	-	-	-	-	-
Extra Dry	X	X	X	-	-	X	X	-	X	-	X	X
Extra Silent	-	-	-	X	X	X	-	X	X	-	X	X
Extra Fast	-	-	-	X	X	X	-	X	X	X	X	X
Energy Save	-	-	-	X	X	-	-	X	-	-	-	X
Child Lock	X	X	X	X	X	X	X	X	X	X	X	X

Options Icons:

OPTIONS			
ICON DEFINITION	Control Panel Serigraphy	LED Display Interface	Mobile Application Interface
Prewash Ön Yıkama			
Delay timer Erteleme			
Eco Wash Half Load option Yarım Yük			
Tablet option Tablet			
Extra Hygiene option Ekstra Hijyen			
Extra Rinse option Ekstra Durulama			
Extra Drying option Ekstra Kurutma			
Silent Wash Extra Silent option Ekstra Sessiz			
Extra Fast option Ekstra Hızlı			
Energy Save option Enerji Tasarrufu			
Upper Basket Direct Wash Üst Sepet / Detay Yıkama Teknolojisi			
Lower Basket Triple Wash Alt Sepet / 360° 3lü Yıkama Teknolojisi			
Turbidity Sensor (Smart Wash) Kirlilik Sensörü			

WARNINGS & PHASES			
ICON DEFINITION	Control Panel Serigraphy	LED Display Interface	Mobile Application Interface
Rinse-aid indicator Parlatıcı			
Salt indicator Tuz			
Wash Yıkama			
Rinse Durulama			
Dry Kurutma			
End Bitti			

5.2 COMPATIBILITY BETWEEN OPTIONS

Options	Delay Timer	Half Load (3 modes)	Tablet	Child Lock	Extra Rinse	Extra Hygiene	Extra Dry	Energy save	Extra Fast	Extra Silent
Delay Timer		OK	OK	OK	OK	OK	OK	OK	OK	OK
Half Load (3 modes)	OK		OK	OK	OK	OK	OK	OK	OK	OK
Tablet	OK	OK		OK	OK	OK	OK	OK	OK	OK
Child Lock	OK	OK	OK		OK	OK	OK	OK	OK	OK
Extra Rinse	OK	OK	OK	OK		OK	OK	OK	OK	OK
Extra Hygiene	OK	OK	OK	OK	OK		-	OK	-	-
Extra Dry	OK	OK	OK	OK	OK	-		OK	OK	OK
Energy save	OK	OK	OK	OK	OK	OK	OK		OK	OK
Extra Fast	OK	OK	OK	OK	OK	-	OK	OK		-
Extra Silent	OK	OK	OK	OK	OK	-	OK	OK	-	

5.3 COMPATIBILITY BETWEEN OPTIONS & PROGRAMS

A1 series	OPTIONS	Delay	Half Load	Tablet	Child Lock
PROGRAMS					
Prewash		X	-	-	X
Quick 30'		X	-	X	X
Eco 50°C		X	X	X	X
Super 50'		X	X	X	X
Intensive 65°C		X	X	X	X
Hygiene 70°C → A15_AUS Delicate		X	X	X	X

Note: Half load option(with Prewash/Quick 30' program) cannot be selected for models without diverter. Note: For A15_AUS, DELICATE replaces the Hygiene in A15.

A1 series w/ Autodoor	OPTIONS	Delay	Half Load	Energy Save	Child Lock
PROGRAMS					
Prewash		X	-	-	X
Quick 30'		X	-	X	X
Eco 50°C		X	X	X	X
Super 50'		X	X	X	X
Intensive 65°C		X	X	X	X
Hygiene 70°C		X	X	X	X

A21 A22 Series	Delay	Half load(3 modes)	Tablet	Extra Hygiene	Extra Rinse	Extra Dry	Child Lock
Prewash	x	x	-	-	-	-	x
Quick 30'	x	x	x	-	x	x	x
Delicate 40°C	x	x	x	x	x	x	x
Eco 50°C	x	x	x	x	x	x	x
Daily 60°C	x	x	x	x	x	x	x
Super 50'	x	x	x	x	x	x	x
Intensive 65°C	x	x	x	x	x	x	x

A23 Series	Delay	Half load(3 modes)	Tablet	Extra Hygiene	Extra Rinse	Extra Dry	Child Lock
Prewash	x	x	-	-	-	-	x
Quick 30'	x	x	x	-	x	x	x
Eco 50°C	x	x	x	x	x	x	x
Daily 60°C	x	x	x	x	x	x	x
Super 50'	x	x	x	x	x	x	x
Auto Delicate	x	x	x	x	x	x	x
Auto Normal	x	x	x	x	x	x	x
Auto Intensive	x	x	x	x	x	x	x

A24 Series	Delay	Half load(3 modes)	Tablet	Extra Hygiene	Extra Silent	Extra Fast	Energy Save	Child Lock
Jetwash 14'	x	x	-	-	-	-	x	x
Quick 30'	x	x	x	-	-	-	x	x
Eco 50°C	x	x	x	x	x	x	x	x
Dual Prowash	x	x	x	x	x	x	x	x
Super 50'	x	x	x	x	-	-	x	x
Auto Delicate	x	x	x	x	-	-	x	x
Auto Normal	x	x	x	x	-	-	x	x
Auto Intensive	x	x	x	x	-	-	x	x

A25 Series	Delay	Half load(3 modes)	Tablet	Extra Hygiene	Extra Silent	Extra Fast	Energy Save	Child Lock
Jetwash 14'	x	x	-	-	-	-	x	x
Quick 30'	x	x	x	-	-	-	x	x
Eco 50°C	x	x	x	x	x	x	x	x
Eco 5.4 lt	x	x	x	x	x	x	x	x
Dual Prowash	x	x	x	x	x	x	x	x
Super 50'	x	x	x	x	-	-	x	x
Auto Delicate	x	x	x	x	-	-	x	x
Auto Intensive	x	x	x	x	-	-	x	x

A26 Series	Delay	Half load(3 modes)	Tablet	Extra Hygiene	Extra Dry	Extra Silent	Extra Fast	Child Lock
Jetwash 14'	x	x	-	-	-	-	-	x
Quick 30'	x	x	x	-	x	-	-	x

Eco 50°C	x	x	x	x	x	x	x	x
Dual Prowash	x	x	x	x	x	x	x	x
Super 50'	x	x	x	x	x	-	-	x
Smart 50°C - 70°C	x	x	x	x	x	-	-	x

A27 Series	Delay	Half load(3 modes)	Tablet	Extra Hygiene	Extra Dry	Extra Silent	Extra Fast	Child Lock
Jetwash 14'	x	x	-	-	-	-	-	x
Quick 30'	x	x	x	-	x	-	-	x
Eco 50°C	x	x	x	x	x	x	x	x
Dual Prowash	x	x	x	x	x	x	x	x
Super 50'	x	x	x	x	x	-	-	x
Smart 50°C - 70°C	x	x	x	x	x	-	-	x
Steam Wash	x	x	x	x	x	-	-	x

A28 Series	Delay	Half load(3 modes)	Tablet	Extra Hygiene	Extra Dry	Extra Silent	Extra Fast	Child Lock
Jetwash 14'	x	x	-	-	-	-	-	x
Quick 30'	x	x	x	-	x	-	-	x
Eco 50°C	x	x	x	x	x	x	x	x
Dual Prowash	x	x	x	x	x	x	x	x
Super 50'	x	x	x	x	x	-	-	x
Smart 30°C - 50°C	x	x	x	x	x	-	-	x
Smart 50°C - 70°C	x	x	x	x	x	-	-	x
Steam Wash	x	x	x	x	x	-	-	x

A29 Series	Delay	Half load(3 modes)	Tablet	Extra Hygiene	Extra Dry	Extra Silent	Extra Fast	Child Lock
Jetwash 14'	x	x	-	-	-	-	-	x
Quick 30'	x	x	x	-	x	-	-	x
Eco 50°C	x	x	x	x	x	x	x	x
Dual Prowash	x	x	x	x	x	x	x	x
Super 50'	x	x	x	x	x	-	-	x
Smart 30°C - 50°C	x	x	x	x	x	-	-	x
Smart 50°C - 60°C	x	x	x	x	x	-	-	x
Smart 60°C - 70°C	x	x	x	x	x	-	-	x
Steam Wash	x	x	x	x	x	-	-	x

A31 A32 Series	Delay	Half load(3 modes)	Tablet	Extra Rinse	Extra Dry	Extra Hygiene	Child Lock
Prewash	x	x	-	-	-	-	x
Jetwash 14'	x	x	-	-	-	-	x
Quick 30'	x	x	x	x	x	-	x
Eco 50°C	x	x	x	x	x	x	x
Super 50'	x	x	x	x	x	x	x
Auto Delicate	x	x	x	x	x	x	x
Auto Normal	x	x	x	x	x	x	x
Auto Intensive	x	x	x	x	x	x	x

A33 A34 Series	Delay	Half load(3 modes)	Tablet	Extra Hygiene	Extra Silent	Extra Fast	Energy Save	Child Lock
Jetwash 14'	x	x	-	-	-	-	x	x
Quick 30'	x	x	x	-	-	-	x	x
Eco 50°C	x	x	x	x	x	x	x	x
Dual	x	x	x	x	x	x	x	x
Super 50'	x	x	x	x	-	-	x	x
Auto	x	x	x	x	-	-	x	x
Auto	x	x	x	x	-	-	x	x
Auto	x	x	x	x	-	-	x	x

A35 Series	Delay	Half load(3 modes)	Tablet	Extra Hygiene	Extra Silent	Extra Fast	Energy Save	Child Lock
Jetwash 14'	x	x	-	-	-	-	x	x
Quick 30'	x	x	x	-	-	-	x	x
Eco 50°C	x	x	x	x	x	x	x	x
Eco 5.4 lt	x	x	x	x	x	x	x	x
Dual Prowash	x	x	x	x	x	x	x	x
Super 50'	x	x	x	x	-	-	x	x
Auto Delicate	x	x	x	x	-	-	x	x
Auto Intensive	x	x	x	x	-	-	x	x

A36 Series	Delay	Half load(3 modes)	Tablet	Extra Hygiene	Extra Dry	Extra Silent	Extra Fast	Child Lock
Jetwash 14'	x	x	-	-	-	-	-	x
Quick 30'	x	x	x	-	x	-	-	x
Eco 50°C	x	x	x	x	x	x	x	x
Dual Prowash	x	x	x	x	x	x	x	x
Super 50'	x	x	x	x	x	-	-	x
Smart 50°C - 70°C	x	x	x	x	x	-	-	x

A37 Series	Delay	Half load(3 modes)	Tablet	Extra Hygiene	Extra Dry	Extra Silent	Extra Fast	Child Lock
Jetwash 14'	x	x	-	-	-	-	-	x
Quick 30'	x	x	x	-	x	-	-	x
Eco 50°C	x	x	x	x	x	x	x	x
Dual Prowash	x	x	x	x	x	x	x	x
Super 50'	x	x	x	x	x	-	-	x
Smart 50°C - 70°C	x	x	x	x	x	-	-	x
Steam Wash	x	x	x	x	x	-	-	x

A38 Series	Delay	Half load(3 modes)	Tablet	Extra Hygiene	Extra Dry	Extra Silent	Extra Fast	Child Lock
Jetwash 14'	x	x	-	-	-	-	-	x
Quick 30'	x	x	x	-	x	-	-	x
Eco 50°C	x	x	x	x	x	x	x	x
Dual Prowash	x	x	x	x	x	x	x	x
Super 50'	x	x	x	x	x	-	-	x
Smart 30°C - 50°C	x	x	x	x	x	-	-	x
Smart 50°C - 70°C	x	x	x	x	x	-	-	x
Steam Wash	x	x	x	x	x	-	-	x

A39 Series	Delay	Half load(3 modes)	Tablet	Extra Hygiene	Extra Dry	Extra Silent	Extra Fast	Child Lock
Jetwash 14'	x	x	-	-	-	-	-	x
Quick 30'	x	x	x	-	x	-	-	x
Eco 50°C	x	x	x	x	x	x	x	x
Dual Prowash	x	x	x	x	x	x	x	x
Super 50'	x	x	x	x	x	-	-	x
Smart 30°C - 50°C	x	x	x	x	x	-	-	x
Smart 50°C - 60°C	x	x	x	x	x	-	-	x
Smart 60°C - 70°C	x	x	x	x	x	-	-	x
Steam Wash	x	x	x	x	x	-	-	x

A3Y Series	Delay	Half load(3 modes)	Tablet	Extra Hygiene	Extra Silent	Extra Fast	Energy Save	Child Lock
Jetwash 14'	x	x	-	-	-	-	x	x
Quick 30'	x	x	x	-	-	-	x	x
Eco 50°C	x	x	x	x	x	x	x	x
Eco 5.4 lt	x	x	x	x	x	x	x	x
Dual Prowash	x	x	x	x	x	x	x	x
Super 50'	x	x	x	x	-	-	x	x
Auto Delicate	x	x	x	x	-	-	x	x
Auto Intensive	x	x	x	x	-	-	x	x

A41 Series	Delay	Half load(3 modes)	Tablet	Extra Hygiene	Extra Fast	Child Lock
Prewash	x	x	-	-	-	x
Quick 30'	x	x	x	-	-	x
Eco 50°C	x	x	x	x	x	x
Dual Prowash	x	x	x	x	x	x
Super 50'	x	x	x	x	-	x
Auto Intensive	x	x	x	x	-	x

A42 Series	Delay	Half load(3 modes)	Tablet	Extra Hygiene	Extra Dry	Extra Silent	Extra Fast	Child Lock
Prewash	x	x	-	-	-	-	-	x
Jetwash 14'	x	x	-	-	-	-	-	x
Quick 30'	x	x	x	-	x	-	-	x
Eco 50°C	x	x	x	x	x	x	x	x
Dual Prowash	x	x	x	x	x	x	x	x
Super 50'	x	x	x	x	x	-	-	x
Auto Intensive	x	x	x	x	x	-	-	x

A43 Series	Delay	Half load(3 modes)	Tablet	Extra Hygiene	Extra Dry	Extra Silent	Extra Fast	Child Lock
Prewash	x	x	-	-	-	-	-	x
Jetwash 14'	x	x	-	-	-	-	-	x
Quick 30'	x	x	x	-	x	-	-	x
Eco 50°C	x	x	x	x	x	x	x	x
Daily 60°C	x	x	x	x	x	-	-	x
Dual Prowash	x	x	x	x	x	x	x	x
Super 50'	x	x	x	x	x	-	-	x
Auto Delicate	x	x	x	x	x	-	-	x
Auto Normal	x	x	x	x	x	-	-	x
Auto Intensive	x	x	x	x	x	-	-	x

A44 Series	Delay	Half load(3 modes)	Tablet	Extra Hygiene	Extra Dry	Extra Silent	Extra Fast	Energy Save	Child Lock
Prewash	x	x	-	-	-	-	-		x
Jetwash 14'	x	x	-	-	-	-	-	x	x
Quick 30'	x	x	x	-	x	-	-	x	x
Eco 50°C	x	x	x	x	x	x	x	x	x
Daily 60°C	x	x	x	x	x	-	-	x	x
Dual Prowash	x	x	x	x	x	x	x	x	x
Super 50'	x	x	x	x	x	-	-	x	x
Auto Delicate	x	x	x	x	x	-	-	x	x
Auto Normal	x	x	x	x	x	-	-	x	x
Auto Intensive	x	x	x	x	x	-	-	x	x

A45 Series	Delay	Half load(3 modes)	Tablet	Extra Hygiene	Extra Dry	Extra Silent	Extra Fast	Energy Save	Child Lock
Prewash	x	x	-	-	-	-	-		x
Jetwash 14'	x	x	-	-	-	-	-	x	x
Quick 30'	x	x	x	-	x	-	-	x	x
Eco 50°C	x	x	x	x	x	x	x	x	x
Eco 5.4 lt	x	x	x	x	x	x	x	x	x
Dual Prowash	x	x	x	x	x	x	x	x	x
Super 50'	x	x	x	x	x	-	-	x	x
Auto Delicate	x	x	x	x	x	-	-	x	x
Auto Normal	x	x	x	x	x	-	-	x	x
Steam Wash	x	x	x	x	x	-	-	-	x

A46 Series	Delay	Half load(3 modes)	Tablet	Extra Hygiene	Extra Dry	Extra Silent	Extra Fast	Child Lock
Jetwash 14'	x	x	-	-	-	-	-	x
Quick 30'	x	x	x	-	x	-	-	x
Eco 50°C	x	x	x	x	x	x	x	x
Dual Prowash	x	x	x	x	x	x	x	x
Super 50'	x	x	x	x	x	-	-	x
Smart 50°C - 70°C	x	x	x	x	x	-	-	x

A47 Series	Delay	Half load(3 modes)	Tablet	Extra Hygiene	Extra Dry	Extra Silent	Extra Fast	Child Lock
Jetwash 14'	x	x	-	-	-	-	-	x
Quick 30'	x	x	x	-	x	-	-	x
Eco 50°C	x	x	x	x	x	x	x	x
Dual Prowash	x	x	x	x	x	x	x	x
Super 50'	x	x	x	x	x	-	-	x
Smart 50°C - 70°C	x	x	x	x	x	-	-	x
Steam Wash	x	x	x	x	x	-	-	x

A48 Series	Delay	Half load(3 modes)	Tablet	Extra Hygiene	Extra Dry	Extra Silent	Extra Fast	Child Lock
Jetwash 14'	x	x	-	-	-	-	-	x
Quick 30'	x	x	x	-	x	-	-	x
Eco 50°C	x	x	x	x	x	x	x	x
Dual Prowash	x	x	x	x	x	x	x	x
Super 50'	x	x	x	x	x	-	-	x
Smart 30°C - 50°C	x	x	x	x	x	-	-	x
Smart 50°C - 70°C	x	x	x	x	x	-	-	x
Steam Wash	x	x	x	x	x	-	-	x

A49 Series	Delay	Half load(3 modes)	Tablet	Extra Hygiene	Extra Dry	Extra Silent	Extra Fast	Child Lock
Jetwash 14'	x	x	-	-	-	-	-	x
Quick 30'	x	x	x	-	x	-	-	x
Eco 50°C	x	x	x	x	x	x	x	x
Dual Prowash	x	x	x	x	x	x	x	x
Super 50'	x	x	x	x	x	-	-	x
Smart 30°C - 50°C	x	x	x	x	x	-	-	x
Smart 50°C - 60°C	x	x	x	x	x	-	-	x
Smart 60°C - 70°C	x	x	x	x	x	-	-	x
Steam Wash	x	x	x	x	x	-	-	x

A4Y Series	Delay	Half load(3 modes)	Tablet	Extra Hygiene	Extra Dry	Extra Silent	Extra Fast	Energy Save	Child Lock
Prewash	x	x	-	-	-	-	-		x
Jetwash 14'	x	x	-	-	-	-	-	x	x
Quick 30'	x	x	x	-	x	-	-	x	x
Eco 50°C	x	x	x	x	x	x	x	x	x
Eco 5.4 lt	x	x	x	x	x	x	x	x	x
Dual Prowash	x	x	x	x	x	x	x	x	x
Super 50'	x	x	x	x	x	-	-	x	x
Smart 30°C - 50°C	x	x	x	x	x	-	-	x	x
Smart 50°C - 70°C	x	x	x	x	x	-	-	x	x
Steam Wash	x	x	x	x	x	-	-	-	x

A4Y_UVCT Series	Delay	Half load(3 modes)	Tablet	Extra Hygiene	Extra Dry	Extra Silent	Extra Fast	Energy Save	Child Lock
WaterFree 20'	-	-	-	-	-	-	-	-	-
Jetwash 14'	x	x	-	-	-	-	-	x	x
Quick 30'	x	x	x	-	x	-	-	x	x
Eco 50°C	x	x	x	x	x	x	x	x	x
Eco 5.4 lt	x	x	x	x	x	x	x	x	x
Dual Prowash	x	x	x	x	x	x	x	x	x
Super 50'	x	x	x	x	x	-	-	x	x
Auto Delicate	x	x	x	x	x	-	-	x	x
Auto Normal	x	x	x	x	x	-	-	x	x
Steam Wash	x	x	x	x	x	-	-	-	x

5.4.2. COMPATIBILITY BETWEEN OPTIONS & PROGRAMS (A45_x)

	Delay Start	Half Load (3 modes) or Triple&Direct wash	Tablet	Child Lock	Extra Fast	Extra Hygiene	Extra Silent	Extra Drying
Prewash	X	X	-	X	-	-	-	-
Mini 18'	X	X	-	X	-	-	-	-
Quick 30'	X	X	X	X	-	-	-	X
Eco 50°C	X	X	X	X	X	X	X	X
Eco 5.4lt	X	X	X	X	X	X	X	X
DUAL PRO WASH	X	X	X	X	X	X	X	X

Super 50'	X	X	X	X	-	X	-	X
Auto Intensive 60°/70°C	X	X	X	X	-	X	-	X
Auto Normal 50-60°C	X	X	X	X	-	X	-	X
Auto Delicate 30-50°C	X	X	X	X	-	X	-	X
Steam Wash	X	X	X	X	-	X	-	X

- All options can be selected with eco 5.4lt program. But, when any option is selected in eco 5.4lt program, software start economic 50C program with options that is selected instead of eco 5.4lt.

5.4 OPTION DEFINITION

Option	Short description
Delay Timer	Program starts with a delay
Half Load(3 modes)	The wash is executed with upper spray, lower spray or both in half load mode.
Tablet	Change of washing temperature and time
Child Lock	It can be activated by pressing related buttons at the same time for 3 seconds(see 5.4.4) Buttons are blocked to press.
Extra Hygiene	Increase the washing temperature at final rinse step in order to eliminate bacteria
Extra Dry	This option increases water temperature at final rinse step and increase drying step duration up to 10 min.
Extra Rinse	Extra rinse option adds an extra rinse step to achieve more hygienic washing. Programme duration is increased between min. %4 and max. %16 according to washing programme
Energy Save	At the end of the drying process, the dishwasher door automatically opens to allow steam to escape and cool air to circulate. For A24, A25, A33, A34, A35, A44, A45 models; when the machine turned on, energy save is active for only Eco program as default. This option can not be selected after program starts or paused.
Extra Fast	Reduces the duration of the washing. This option can not be selected after program starts or paused. This option can not be selected after program starts or paused.
Extra Silent	Reduces the sound pressure level of the washing This option can not be selected after program starts or paused.

Note: While option selection, related option led blinks. When user activates option and its led becomes on, next option led starts to blink.

Selecting the Options

5.4.1 Delay Timer

The delay timer option is selected by pressing the regarding button before the program starts. It is possible to select the delay before selecting the program.

Before program is started, all indicator leds and delay led are OFF. For

models w/o display:

When delay button is pushed first,

- 6h led is OFF, and 3h led is ON. (It means program starting is delayed 3 hours)

When delay button is pushed second,

- 3h led is OFF, 6h led is ON. (It means program starting is delayed 6 hours)

When delay button is pushed third,

- 3h and 6h leds are ON. (It means program starting is delayed 9 hours)

When delay button is pushed fourth,

- 3h and 6h leds are OFF. (It means delay process is cancelled)

If user presses Start/Stop button when a delay time is selected, the program with delay will be in operation. Start/Stop led is ON.

When user activates 9h delay timer, after 3 hours 9h leds becomes off. Only 6h led is on. After 3 more hours is passed, 6h led becomes off and 3h becomes on.

When user activates 6h delay timer, after 3 hours 6h led becomes off and 3h led becomes on. For

models w/ display:

Before starting the program,

- Delay is selected by consecutive pressures of the button. Delay led is ON.
- At each pressure, the display shows one step of increment (from H:01 to H:24); having been reaching its maximum value (H:24)
- If user hold pressing continuously, delay timer starts counting faster (acceleration is proportional to the hold pressing time). In case of a long period of time pressed to delay button, counter stops at " H:00".
- The next pressure clears the delay and shows "H:00".
- Before pressing Start/Stop button, selected program duration and delay durations are shown on the display alternately in 2" interval.
- After pressing Start/Stop button, Delay led blinks once, delay duration is shown on the display and the program with delay will be in operation.

Cancelling the delay start is possible during the delay time.

- Press the delay button, until the delay time is "H:00"
- Press Start/Pause button and the washing program will start.
- Switch Off and On the machine

- **When delay timer is selected, if machine switch off and on by ON/OFF button, delay timer is cancelled and machine goes to ready state.**
- **If mains power off-on occurs (power cut); delay time resumes, does not start again.**
- **When delay timer is selected but not started or started and paused, if any program button is pressed, delay timer is cancelled and machine goes to ready state.**

After the delay timer starts counting down,

- if the option changes, delay timer continues down from the time when option is changed.

- If the delay time is changed; delay starts from the beginning of the new delay time.

5.4.2 Half Load

For models w/o display;

Half load is enabled/disabled by pressing “Half load” button”.Half load led is ON.

For models w/ display-w/o diverter;

Half load is enabled/ disabled by pressing “Half load” button once and Half load led becomes ON.

For models w/ display-w/ diverter;

If neither half load option is selected before, “Upper Basket” and “Lower Basket” leds are OFF.Half Load option is selected before program start by pressing “options” button.

When Options button is pressed:

First time: Tablet led blinks.

Second time: Tablet led is OFF. Upper Basket led blinks. In order to select Upper Basket option, press select button and Upper Basket led will be on. Then, first option led start to blink. Wash is executed only with upper spray arm.

Third time: Upper Basket led is OFF and Lower Basket led blinks. In order to select Lower Basket option, press select button and Lower Basket led will be on. Then, first option led start to blink. Wash is executed only with lower spray arm.

5.4.3 Tablet

Tablet option is selectable at any time. If it is pressed during a washing program the program will execute the following steps with “tablet” functions instead of the normal.

For models w/o diverter;

Tablet option is selected by pressing “Tablet” button. Tablet led is ON.

For models w/ diverter;

Tablet option is selected by pressing “Options” button until tablet led blinks and pressing “select” button.

When user selects tablet option, main wash temperature is determined according to tablet temperature under no circumstances. Even if another option or automatic program is run together with the tablet option.

Temperature value of tablet option is determined according to dissolution temperature of tablet detergent.

5.4.4 Child Lock

For models w/o display-w/o diverter;

Child lock is enabled/disabled by contemporary pressure of “Tablet” and “Delay” buttons for 3”. When it is activated, child lock led is on.

If lock is active and the buttons are pressed, the Child lock led blinks once.

For models w/ display-w/o diverter;

Child lock is enable/disabled by pressing “Tablet” button for 3”.

For models w/ display-w/ diverter;

Child lock is enable/disabled by pressing “Select” button for 3”.

For A4 model;

Child lock is enabled by touching Child lock icon on the display for 3”.

When lock is enabled, all leds blink and Display shows “CL” once When lock is disabled, all leds blink and Display shows “CL” twice

When lock is enabled and a button is touched, all leds blink and Display shows “CL” twice

Note: When user starts a programme with delay and activates child lock: if user turn off/on the machine or power cut occurs; both delay and child lock is active when machine is energized.

Note: If user activates child lock then turns off/on the machine or power cut occurs; child lock will be active when

machine is energized. (valid from 22.09.2020)

Valid from 11.01.2021; in any mode (ready, run, pause, end, delay start), while the child lock is active,

- if the machine turns off and on again by on/off button, the child lock will stay active when the machine is energized. It will not be cancelled.
- if the mains power (220 V) is cut and machine is energized again, the child lock will be cancelled. (For the first phase of Vel sw's this behaviour is same with on/off button, this will be implemented on the 2nd phase)
- If the machine is turned off automatically 15 minutes after any usage, the child lock will stay active when the machine is energized.
- If the power cut occurs after machine is turned off by on/off button, the child lock will stay active when the machine is energized.

5.4.5 Extra Options (for models w/ display)

Extra option is selected before program start by pressing "Options" button and regarding led is ON. When

Options button is pressed;

First time: Tablet led blinks.

Second time: Upper basket led blinks.

Third time: Lower basket led blinks.

Fourth time: Hygiene led blinks, all the other leds are OFF. Wash is executed with the following steps with "Hygiene" functions instead of the normal.

In models with Auto Door, 4th led is Energy save. So, Energy Save led is on instead of Hygiene.

Fifth time: Rinse led is blinks, all the other leds are OFF. Wash is executed with the following steps with "Rinse" functions instead of the normal.

In models with BLDC, 5th led is Extra Fast. So, Extra Fast led is on instead of Rinse.

Sixth time: Dry led blinks, all the other leds are OFF. Wash is executed with the following steps with "Dry" functions instead of the normal.

In models with BLDC, 6th led is Extra Silent. So, Extra Silent led is on instead of Dry.

Seventh time: Tablet led blinks.

In order to select a desired option, user must press Select button after desired option's led is on. When user selects option and its led becomes on, first option led starts to blink.

Note: Hygiene and Dry options cannot be selected together. Hence, Hygiene+Dry+Rinse cannot be selected also.

Note: Fast and Silent options cannot be selected together. Hence, Energy save + Fast + Silent cannot be selected also.

Note: For A2, A3 models; after selection of any option, the new option selection starts with the next of the before selected option. (It is valid for new models- 01.03.2020)

5.4.6 Favourite Program

User selects program and option(s). Then presses button combination for favorite program storing. When the favorite program is stored, related program and option leds blink once.

To activate favorite program, user presses button for favorite program selection during 3". Then, related program and option leds become on.

Favorite program storing and activation can be done in standby and pause mode.

(If no favourite program was selected before, and if the favourite program is selected, the latest program and option is saved as favourite program)

A1 without display:

A15

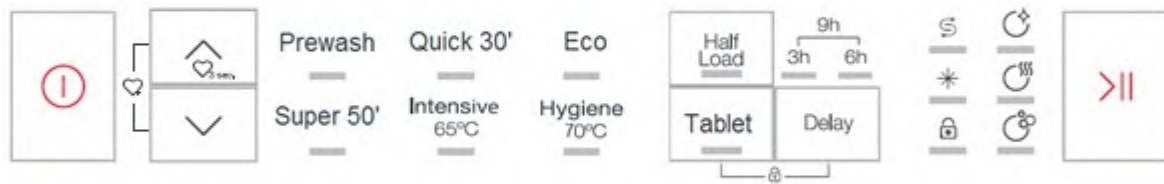

button combination for favorite program storing : up + down buttons button for

favorite program selection: up button

A1 with display A2 and A3:

A1E



A25





button combination for favorite program storing : program + delay buttons button

for favorite program selection : program button

5 SOFTWARE REQUIREMENTS

6.1 HEATER

Heating relay must be switched with un-supplied Heater.

- Stop Circulation Pump.
- Wait for pressure switch certainly open.
- Open/Close Heater Relay
- Wait (Heater relay certainly close);
- Start Circulation Pump.

If Tablet is selected, heating steps must be < 55°C for steps before last rinse.

6.2 WATER FILL

Water Load is obtained by flow meter signals. When a fixed quantity of water is loaded, the reaching water level is checked by the activation of circulation pump. When the pressure is high enough, the pressure switch is activated.

For 1L water inlet, MCU must detect 210 Pulse/L (with +-5% tolerance) from flowmeter .

At the start program a drain 20" + empty is executed before fill.

When Inlet valve is ON, if there aren't flow meter impulses, failure routine of "absence of flow meter impulses routine" works (see on failure chapter).

If pressure sensing switch turns OFF during the wash, after a drain +20", another water load is executed (also see "return empty level" failure in failure chapter).

Water fill must work;

- Pressure > 0,8l: all OK
- 0,3<pressure<0,8l:OKwith time out
- Pressure< 0,3l: stop cycle. Water fill is

performed spray arms start.

Note:

A1: upper spray arm and lower spray arm start together. A2-A3-

A4: lower spray arm starts.

6.3 WATER DRAIN

Water drain starts with drain pump ON for 33". After 30", circulation pump ON. When empty level is recognized (by pressure switch signal), the circulation pump stops and the machine continues for the request steps.

If pressure switch level doesn't switch in Empty level (during circulation pump on), failure of Water drain works (see 8.failure routines).

Water drain is performed with lower spray arm

Note:

A1: drain is performed with upper and lower spray arms. A2-

A3-A4: drain is performed with lower spray arm.

Detergent dispenser step

After wash+heating step is started 3 seconds, Dispenser is activated during 0,3 seconds. If power fail or opening door or pushing Start/Stop or switching OFF is happened, Detergent dispenser step is started again.

A2: for the detergent step 2' of upper spray arm are performed.

Rinse aid dispenser step

Dispenser is activated 8 seconds for each dosage. There are 8 seconds between two activations. If power fail or opening door or pushing Start/Stop or switching OFF is happened, Dispenser activation resumes.

If the door is opened and re-closed during washing program, without a re-start program, detergent dispenser must return in Rinse aid distribution state.

A2: for the rinse aid step 2' of upper spray arm is performed.

Sliding dispenser dosages are shown below in detail.

1 rinse aid dosage is performed when dispenser is ON during 8" and OFF during 8". =>1,5cc 2 rinse

aid dosages are performed 8" ON-8" OFF-8" ON-8" OFF=>3cc

3 rinse aid dosages are performed 8" ON-8" OFF-8" ON-8" OFF-8" ON-8" OFF=>4,5cc

4 rinse aid dosages are performed 8" ON-8" OFF-8" ON-8" OFF-8" ON-8" OFF-8" ON-8" OFF =>6cc

<i>Action</i>		<i>New(Sliding dispenser)</i>	
Detergent cover opening:		0.3"	
Rinse aid dose:	Dose setting:	Automatic in the software	
	Dose quantity and time to delivery	1 - 0cc	OFF
		2 - 1.5cc	8"ON; 8"OFF
		3 - 3cc	8"ON; 8"OFF
		4 - 4.5cc	8"ON; 8"OFF
		5 - 6cc	8"ON; OFF
		n/a	n/a
Standard dose of rinse aid setting by manufacturer		(4-4,5cc set by software)	

6.4 REGENERATION CYCLE

When it occurs the regeneration valve works after last rinse and during the drying steps. There are 6 hardness levels.

Water Hardness level	Litres
Level 1	Never
Level 2	116 lt
Level 3	64 lt
Level 4	52 lt
Level 5	46 lt
Level 6	16 lt

The consumed liters are counted by flow meter impulses.

In case of flow meter broken, the liters corresponding at the flow meter time out are used

If user cancels a program during regeneration or after regeneration and before resin wash, at the beginning of the next program the dishwasher performs the resin wash to remove the salty water from the resin chamber. The resin wash will be: load 2 lt of water with drain pump on. During the resin wash the circulation Pump must be off.

Regeneration is not performed at prewash program

If water hardness level is changed from lower to higher, regeneration cycle is performed at the end of the first program. If water hardness level is changed from higher to lower, regeneration cycle is not performed at the end of the first program. Regeneration is performed after water level reach to value of level

- If Water hardness level is 5 or 6
 - First regeneration step is performed 0,2lt water
- If Water hardness level is 2 or 3 or 4
 - First regeneration step is performed 0,1lt water
- If Water hardness level is 1
 - Regeneration step is not performed

-The consumed liters are counted by FLM(flow meter) impulses.

-In case of FLM broken, the liters corresponding at the FLM time out are used. (2,1 lt + 2,5 lt).

-In case of "Tablet" option is ON ;

- *If the level set is less than L4: the regeneration cycle is not performed, but the quantity of consumed water is counted. When the target value is reached, at the first cycle without the "Tablet" ,the regeneration cycle is performed.
- *If the level set is equal or more than L5: the regeneration cycle is performed when the quantity target is reached.

-If the washing program is a "prewash program", the regeneration cycle is not performed.

-If user cancels a program during regeneration or after regeneration and before resin wash, at the beginning of the next program the dishwasher performs the resin wash to remove the salty water from the resin chamber. The resin wash will be: load 2 lt of water with drain pump on.

-During the resin wash, the circulation Pump must be OFF.

-If the level of regeneration step is incremented, (for ex:from level3 to level 6) ,at the end of the next washing cycle, it must perform resin wash.

-If the regeneration level is decremented, (for ex: from level4 to level 3); checked how much water used until then and according to new level, how much water will be used more for resin wash is calculated.(level 3=64 lt- used liters until then).

-During waiting step of regeneration process, end user open/close the door or Power OFF /ON condition, program goes to END, but next step of washing cycle starts with resin wash, so that water level resets to zero and re-counts down from corresponding water level.

- When there is no flowmeter connection (by removing flowmeter cable), Electronic card saves the water as 4,58 lt per step.

-If there occurs regeneration step after the programs without drying step or programs having less than 15min drying step, at the end of the program (before reg cycle) the duration must be corrected from 0:01 to 0:15 and recount down during reg step.

6.5 FEATURE OF TIME PHASE

- At the beginning of the main wash of eco program, If temperature of water < 30C , Time phase is not activated at the main wash of eco program
- At the beginning of the main wash of eco program, If temperature of water > 30C , Time phase is activated at the main wash of eco program
- These two rules cover only eco programs.

6.6 VOLTAGE SENSING CONTROL

When main supply voltage is below 145VAC, voltage sensing circuit detect low voltage and program is stopped by software.

Take memory failure code of low voltage to show at the beginning of service test. After main supply voltage is above 155VAC, program is started again

When main supply voltage is above 285VAC, voltage sensing circuit detect high voltage and program is stopped by software.

Take memory failure code of high voltage to show at the beginning of service test. After main supply voltage is below 275VAC, program is started again

- If voltage is low or high during 3 hours or more, at the end of the 3 hours:
 - Program go to failure routine without draining, Failure code of low voltage is shown to user
 - Program go to failure routine without draining , Failure code of high voltage is shown to user

For 110V models: Low voltage detection is not available, only high voltage is detected as following:

When main supply voltage is above 145VAC, voltage sensing circuit detect high voltage and program is stopped by software.

Take memory failure code of high voltage to show at the beginning of service test. After main supply voltage is below 135VAC, program is started again

- If voltage is high during 3 hours or more, at the end of the 3 hours:
 - Program go to failure routine without draining , Failure code of high voltage is shown to user

6.7 NTC VALUES

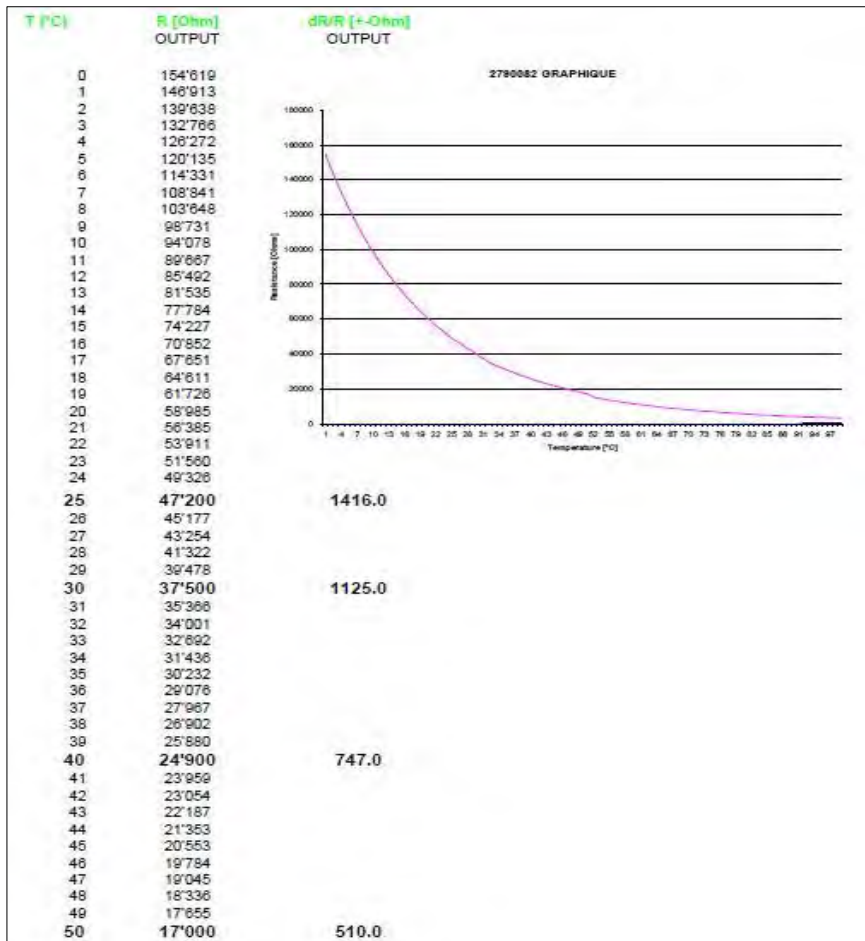

T (°C)	R (Ohm)	dR/R (+-%)
51	16'371	
52	15'766	
53	15'185	
54	14'626	
55	14'090	
56	13'573	
57	13'077	
58	12'600	
59	12'141	
60	11'700	351.0
61	11'295	
62	10'905	
63	10'531	
64	10'171	
65	9'824	
66	9'491	
67	9'171	
68	8'862	
69	8'566	
70	8'280	248.0
71	8'005	
72	7'740	
73	7'485	
74	7'240	
75	7'004	
76	6'776	
77	6'557	
78	6'345	
79	6'141	
80	5'945	178.0
81	5'756	
82	5'573	
83	5'397	
84	5'227	
85	5'064	
86	4'906	
87	4'753	
88	4'606	
89	4'464	
90	4'327	
91	4'195	
92	4'067	
93	3'944	
94	3'825	
95	3'709	
96	3'598	
97	3'491	
98	3'387	
99	3'287	
100	3'190	

6.8 WATER HARDNESS SET

Only service can execute this procedure. This procedure erases the cycle counter. For AU Y models, water hardness level is level 1 as default.

For models w/o display;

- Power ON and press Up button at least for 3". (a bip voice will sound when salt setting is recognized)
- If "Hardness set" is recognized all leds blink for 2". This means that all leds blink once.
- Release Up button. The last setting level is viewed*.
- Press Up button to increase
Press Down button to decrease the level.

At any pressure of up button hardness level is increased. Hardness

level 1 returns after hardness level 6.

At any pressure of down button hardness level is decreased. Hardness level 6 returns after hardness level 1.

* If it is the first hardness set, hardness level is level 3.

Level	Wash	Dry	End
1	FIX	OFF	OFF

2	OFF	FIX	OFF
3	OFF	OFF	FIX
4	FIX	FIX	OFF
5	FIX	OFF	FIX
6	OFF	FIX	FIX

For models w/ display;

- Power ON and press program button at least for 3". For A4 models, use delay button and press it for 3".
- If "Hardness set" is recognized "SL" is shown for 2".
- Release program button. The last setting level is viewed*.
- Press program button to set the desired level.

Level	Display
1	L1
2	L2
3	L3
4	L4
5	L5
6	L6

At any pressure of program button hardness level is incremented. Hardness level 1 returns after hardness level 6.

* If it is the first hardness set, hardness level is L3.

6.9 RINSE AID SET

In order to enter rinse aid set, user applies below steps.

- Power ON; press Up button at least for 5" for models without display → (double bip voice will sound when rinse aid setting is recognized)
- Power ON; press Program button at least for 5" for models with display. For A4 models, use delay button and press it for 5".
- If "Rinse aid set" is recognized; all leds blink twice if model is without display. If model has display, "rA" is shown.
- Release program button. The last setting level is viewed*.
- Press program button to set the desired level.

At any pressure of program button rinse aid level is incremented. The level

1 returns after level 5.

For models without display; rinse aid levels are the same with water hardness levels as shown in the table.

Level	Wash	Dry	End
1(0cc)	FIX	OFF	OFF
2(1,5cc)	OFF	FIX	OFF
3(3cc)	OFF	OFF	FIX
4(4,5cc)	FIX	FIX	OFF
5(6cc)	FIX	OFF	FIX

For models with display;

Level	Display
1(0cc)	r1
2(1,5cc)	r2
3(3cc)	r3
4(4,5cc)	r4
5(6cc)	r5

* If it is the first rinse aid set, Default rinse aid level is 4 which corresponds to 4,5 cc.

If the rinse aid tank is empty and user sets rinse aid level as 1(0cc), "lack of rinse aid" warning is not shown.

6.10 IONIZER(for A1 with T board,A2,A3,A4)

When machine is powered on, Ionizer function can be activated/deactivated by pressing Options button for 3". For A4 models, use upper basket touch button. Display shows "Ion". During activation of ionizer, display counts 1-2-3- Ion. During deactivation of ionizer, display counts 1-2-3 and machine goes ready state.

Also, when machine is turned off and then on, ionizer function is cancelled.

Ionizer cycle is as follow: 5' ON, 55' OFF, 5' ON,55' OFF,.. After 24 hours is completed, ionizer function is deactivated automatically by software.

During 5' ON; ionizer led and ionizer fan work together. During 55", they do not work.

Ionizer must not work within a program. When ionizer is activated, selected options are resetted. When the door is opened, ionizer+mini fan stops. They do not work.

If ionizer is active, Ion led and inner light are on when the door is opened. Ion led lights up like dimming. For A1 models using T board; ionizer activation buttons are as below:

A1 w/o display models using BM05: press down button for 3"

A1 w display models using BM05: press delay and tablet buttons for 3" When

Ion is active:

- 1st and 2nd program leds are on for A1 w/o display models
- Ion is shown on the display for A1 with display models.

Ionizer function can be cancelled

Note: If the model has ION; When the ion is activated and the door is closed, the ionizer mini fan operates. Since the connection of ionizer mini fan and UVON LED is common in hardware, they both work together. Thus during ion mini fan working, the uvon LED is also on or vice versa.

6.10.1 UVON Tect

Uvon function are optional for only BLDC models. Asynchronous models do not have this function.

For 60 cm BLDC models:

UVON function is activated/deactivated by pressing "Options" button at least 6". Meanwhile, display counts from "1 to U1/U0" (1-2-3-ION-4-5-U1/U0 justified to right) alternately and they show "U1" for 2" to indicate that Uvon is activated or 'U0" for 2" to indicate that uvon is deactivated. If user presses less than 6", Ion is activated.

UVON is active only in program having drying phase. If UVON is activated and washing program is started, UV led turns on during the first 10 minutes of drying phase.

UVON led is driven from the same output with ionizer fan.

Also, if regeneration occurs and UVON is active, UV led is on during the first 10' of regeneration. Default set is U0.

At the end of program, if user don't deactivate it, UVON remains active until machine is turned off and on.

UV led is never ON when the door is open. Status of leds are given below:
ram is

& UVON ON

After machine is turned off and on, UVON turns OFF

State & UVON	UVON is OFF		Standby & UVON is ON		Program is washing & UVON is ON		During first 10' of Drying Phase & UVON is ON		After first 10' of Drying Phase & UVON is ON		Program is end & UVON is ON		After machine is turned off and on, UVON turns OFF	
	open	close	open	close	open	close	open	close	open	close	open	close	open	close
UV-A led	x	x	x	x	x	x	x	✓	x	x	x	x	x	x
Ionizer leds	x	x	✓	x	✓	x	✓	x	✓	x	✓	x	x	x

Note: If UVON is active, Ion led lights up like dimming during the door is open.

X: led is off

✓:led is on

For A24 7, A33-A34 7, A41-A42 7, A44 7 (45 cm) models:

For only these slim models, since UV is driven same pin with DC fan, UV led is on during the fan is active on the drying phase with fan as default. During the drying without fan, UV led is off. (UV led lighting does not depend on

UVC NOTE: In models with only UVC, only the following feature will be different from other models:

- There is no ion function, UV is activated/deactivated by pressing the relevant button for 3 seconds. in the form of 3-2-1-U0 / U1.

UVC on TOP: Features that is specific for models including UVC on top of tub are listed in below:

- Includes WaterFree 20' (UVC) program instead of any existing program depending of the model. If this program selected or started, program minutes and "ULC" appears on the display alternately. During the WaterFree 20' program, UVC leds lights on for 20 minutes.
- If UVC (with water) option is activated, it only works at the last 3 minutes of the drying phase of any program (instead of first 10 minutes on current models).

6.11 DEFAULT TURBIDITY(for A21,A22)

A21 and A22 models with sliding dispenser have default turbidity function. Thanks to this, auto program works when turbidity is connected. Intensive program works when turbidity is not connected.

Models with turbidity contains FA error, the others does not.

6.12 INNER LIGHT(for A1 w/ display A1 models using T board,A2,A3,A4)

Machine must be ON position during activation and deactivation of inner light modes. Open or close position of the door is

not important.

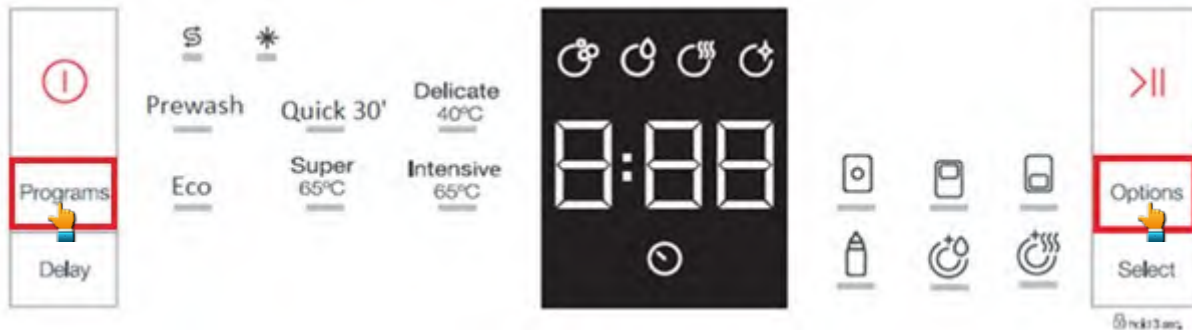

How to change from “ECO MODE” to “NORMAL MODE” for Inner Light option

First energize the machine via On/Off button. (if it is in OFF position). Press Program and Options buttons for 3 seconds.

For A1 with display; press Program and Half load buttons for 3 seconds.

For A1 without display(using BM05); press UP and Half load buttons for 3 seconds. If Normal mode is on, Wash+Dry leds turn on.

“IL0” will be shown in the display for 2 seconds to show the “Normal Mode” is selected for inner light option.

After “Normal Mode” is selected, the inner light will be ON as long as the machine is energized and machine door is open.

How to change from “NORMAL MODE” to “ECO MODE” for Inner Light option First energize the machine via On/Off button. (if it is in OFF position).

Press Program and Options buttons for 3 seconds. For A1 with display; press Program and Half load buttons for 3 seconds.

“IL1” will be shown in the digit display for 2 seconds to show the “Eco Mode” is selected for inner light option. For A1

w/o display models: If Eco mode is on, Wash+Dry+End leds turn on.

Also inner light turns OFF and ON again (blinks momentarily) to show this selection is activated.

After “Eco Mode” is selected, the inner light will be ON for 2min after machine door is opened and then turns OFF.

If any user intervention occurs such as pressing buttons, Eco Mode cycle starts from beginning (inner light is ON for 2min and then becomes OFF again)

For all A models, in ready state (when the machine is in ready mode, after the end of program, or, after the program is cancelled) if there is no intervention for 15 minutes, machine turns off except washing mode (except when WIFI REMOTE CONTROL is active)

When Wifi Remote Control is ON Machine does not turn off automatically. The screen goes to sleep mode 15 minutes after the ready state or program finished.

LED's do not change the operation or brightness in Eco mode.

For models with interior light, the interior light becomes off 2 minutes after the door is opened. Factory

setting for inner light is set to “IL1”.

For A4 series, inner light combination button is lower basket touch button. Press it for 3” to enter inner light set.

6.13 AUTOMATIC PROGRAM(TURBIDITY SENSOR)

Turbidity sensor is performed in the “auto delicate”, “auto normal” and “auto intensive” programs.

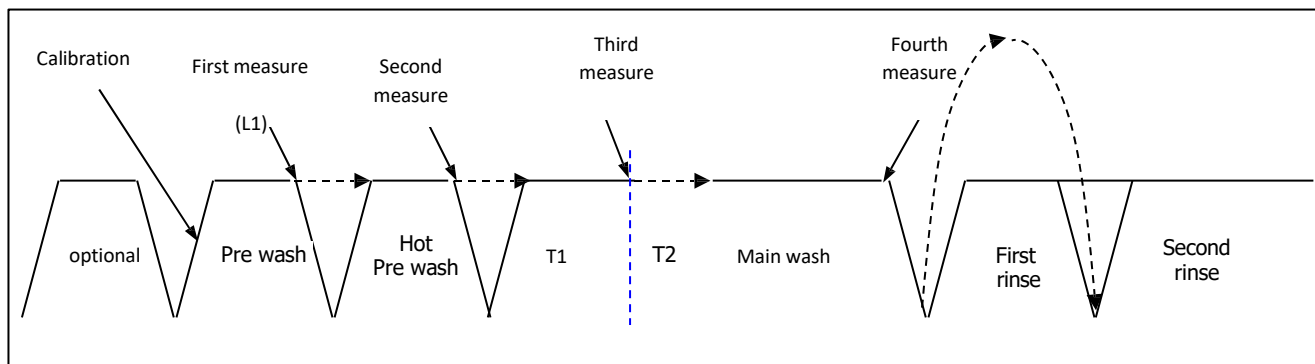

- 1) The calibration is executed after reaching P1 level in the first filling step.
- 2) The first measure is executed at the end of pre-wash.
 - If turbidity is \leq TURBIDITY-LEVEL 1: drain is skipped.
 - If turbidity is $>$ TURBIDITY-LEVEL 1: drain is skipped.
- 3) The second measure is executed at the end of hot pre-wash.
 - If turbidity is \leq TURBIDITY-LEVEL 2: Drain is skipped.
 - If turbidity is $>$ TURBIDITY-LEVEL 2: Drain is skipped.
- 3) The third measure is executed after the first heating step in the main wash.
 - If turbidity is \leq TURBIDITY-LEVEL 3: The second heating step is skipped
 - If turbidity is $>$ TURBIDITY-LEVEL 3: The second heating step is performed (T24_7 is performed)
- 4) The fourth measure is executed at the beginning of rinses.
 - If turbidity is \leq TURBIDITY-LEVEL 4: First rinse is skipped.
 - If turbidity is $>$ TURBIDITY-LEVEL 4: First rinse is executed.

The levels :

TURBIDITY-LEVEL 1 = 3,0V

TURBIDITY-LEVEL 2 = 3,4V

TURBIDITY-LEVEL 3 = 3,7V

TURBIDITY-LEVEL 4 = 3,8V

In case of break of turbidity sensor, the Automatic cycle is entirely executed. The fault is not reported.

6.14 AUTODOOR OPEN SYTEM

Energy save option is not selectable at any time. During program, energy save option cannot be cancelled or cannot be added. If user presses energy save button during program, the buzzer gives a long sound that is activated to warn that this is not a valid command.

Energy save option is enable by firstly pressure of Extra button (Energy save led lights up) before starting the program.

Energy save option is disabled by pressing Extra button until Energy save led turns off.

- When option is selected, The door is opened by the Door Open System at the end of washing program.
- Program in the 1 (Last 1 minute before program finishing)
 - Start to count 2 minutes in the memory
 - TY4 triac is driven by microcontroller and door open system is energized
 - The buzzer gives sound (1"ON + 4"OFF) until auto door mechanism open the door
 - There is 1 on the display during this time.
- When Auto door mechanism open the door
 - TY4 triac is not driven by microcontroller
 - There is 0 on the display.
 - Stop to count 2 minutes in the memory
- If Auto door is not opened in 2 minutes
 - TY4 triac is not driven by microcontroller
 - There is 0 on the display.
 - FC failure code is saved to memory

Machine must be ON position during activation and deactivation of door open system. Position of the door (open/close) is not important to activate/deactivate the system. But during washing cycle, it is not enabled to activate

/deactivate to this feature.

- How the system works:
 - o The unlocked door goes down.
 - o TY4 triac are used to control of auto door mechanism.
 - o The mechanism stops the door at 10 cm opening.
- Benefits:
 - o At hot rinse step, the water is heated up to reasonable values and A class drying is provided by letting the steam flow away to air from the dishwasher.
 - o Some of required heating energy for drying is saved at hot rinse step. Factory

setting for auto door open system is set to "OFF" except Eco program Factory setting

for Eco program is set to "ON".

Auto door option button is illuminated (ON) when user selects at only Eco program by each pressing program selection button.

In Eco program, Auto door must be opened in every cycle until the end user unselect the Energy save option for Eco program. That is to say, In first cycle of Eco or other cycles, Auto door system must be performed (ON) until end user deactivate Auto door system.

Due to Eco design requirements, each energized of the machine (by pressing ON/OFF) Eco program must be fixed as default, energy save option led must be ON(only valid for Eco) and the options that are chosen before will be cancelled.

For ex: when user power OFF/ON→ Eco program is fixed as default, energy save option led is ON.

Then if user press again program button, in this case machine passes to Dual pro wash, but energy save option led must become OFF.

6.15 AUTODOOR CONTROL TEST

	A1 w/o disp	A1 w/disp	A2	A3	A4
Autodoor control test activation buttons	Energy Save (hold) -> power on -> Energy Save 3"	Half Load (hold) -> power on -> Half Load 3"	Options (hold) -> power on -> Options 3"	Options (hold) -> power on -> Options 3"	Options (hold) -> power on -> Options 3"

For A2, A3; press "Options" button. For A4, use energy save button. For A1 with digit use "Half Load" button. For A1 without digit use "Energy Save" button.

Switch-on the dishwasher. Keep pressing Options / Energy Save / Half Load button for 3". After 3", display shows "dco" (means that Door control) characters during 2 sec, then "0:01" characters appear.



- Program in the "0:01" (Last 1 minute before program finishing)
 - o Start to count 2 minutes in the memory
 - o TY4 triac is driven by microcontroller and door open system is energized
 - o The buzzer gives sound (1"ON + 4"OFF) until auto door mechanism open the door
 - o There is 1 on the display during this time.
- When Auto door mechanism open the door
 - o TY4 triac is not driven by microcontroller
 - o There is 0 on the display.
 - o Stop to count 2 minutes in the memory

- If Auto door is not opened in 2 minutes
 - TY4 triac is not driven by microcontroller
 - There is 0 on the display.
 - FC failure code is saved to memory

-Test can be finished by pressing On/Off button.

- For A1 without digit models below leds will be on during this test:

	When the test recognized <after 3">	After 2" during the first step;	During the second step;
For A1 w/o display	Energy Save + 3h + Wash leds (during 2 sec)	3h + Dry leds	3h + End leds

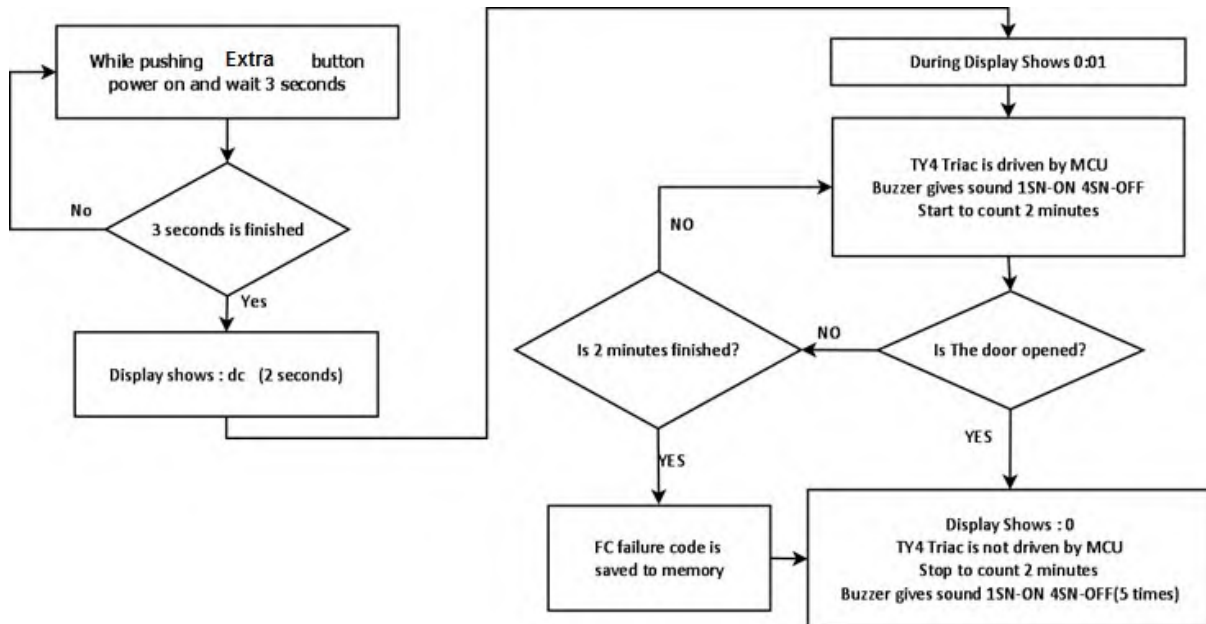
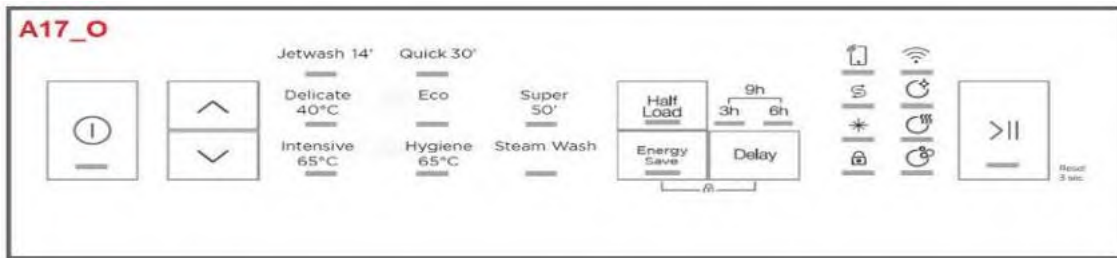

6.16 BLDC MOTOR CONTROL TEST

Press "Select" button. Switch-on the dishwasher. Keep pressing "Select" button for 3".

For A4 models,press upper basket touch buttoni turn on machine and continue to press upper basket button for 3".

Increase level by pressing upper basket touch button Decrease level by pressing lower basket touch button.

After 3", display shows "Pco" (means that Pump control) characters during 2 sec, then "200" characters appear and BLDC motor start performing with 2000 rpm.



Rpm values can be raised or decreased one by one.

Press "Options" button to raise RPM values from 2000 to 3400.(200,210,220,...,340)

Press "Select" button to decrease RPM values by hundred from 3400 to 2000.(340,330,320,...,200)

-Test can be finished by pressing On/Off button.

6.17 WATER SAVE CONTROL TEST

	A1 w/o disp	A1 w/disp	A2	A3	A4
Water save control			power on->options + select 6"	power on->options + select 6"	Power on -> Ext. DRY 3"

After 5", display shows "rc" (means that recovery control) characters during test. The buzzer gives sound (1"ON + 4"OFF) during test except "buzzer sound finishes step" in below diagram.

Pressing any button does not affect the test and any invalid buzzer sound is not heard while water save algorithm in below diagram is continuing.

At the end, buzzer gives long sound.

Test can be finished by pressing On/Off button. Notes:

1. If a program is started after Eco/Eco5.4lt program, water inside the water save tank is drained at the beginning of the program. It is not necessary to terminate the Eco or Eco5.4lt program to execute draining on the beginning of the next program, it is sufficient to start it. Draining takes 4 minutes.
2. After water save tank is full, user must press Program button to continue the test. If Program button is not pressed, test does not continue.
3. If machine turns off/on while test is being executed, machine turns to standby position.

During the test below algorithm is applied:

For one WR tank:

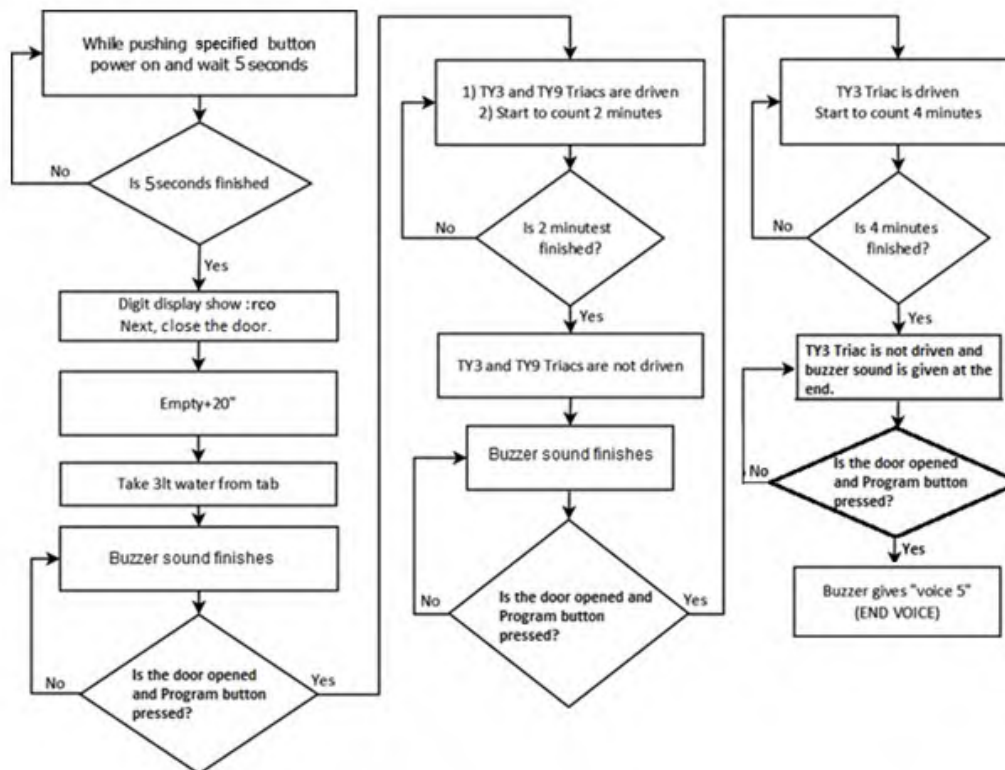

For two WR tanks:

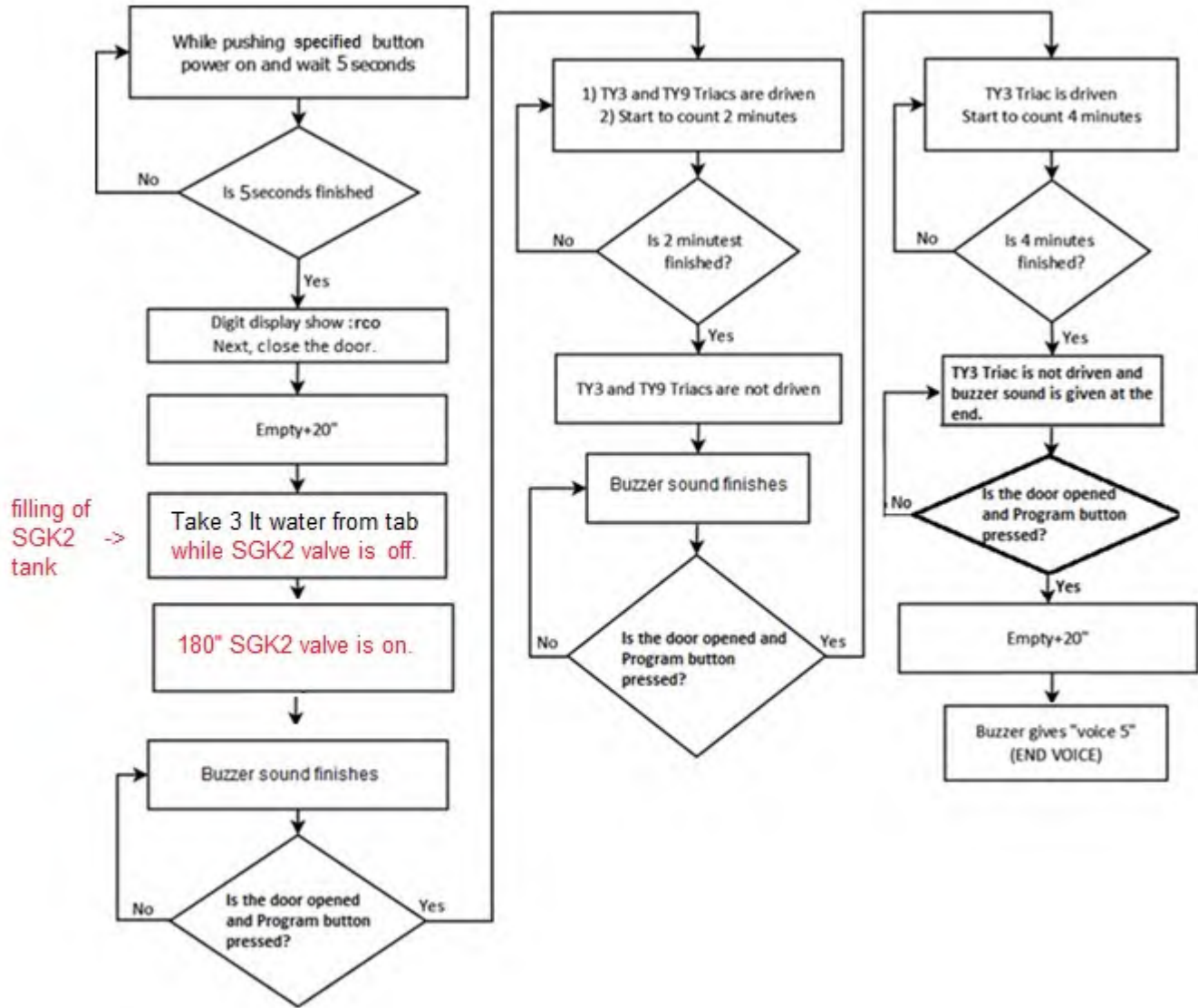

6.18 VOICE CONTROL TEST (for models having Auto Door mechanism)

First energize the machine via main switch (if it is in OFF position). Press option and select buttons for 3".

If voice controlling is done first time, at the end of 3 seconds, "S:03" is shown in the display and Buzzer gives a long sound. (level of 3) (Factory setting is set to "S:03")

User can open or close the voice level with "Program" and "S/P" buttons. The characters must be as follow; By each

pressing "Select" button,

- Display screen changes S:03 to S:00
- Level of sound is decreased
- "S:00" level that means all voices are off

By each pressing "Option" button

- Display screen changes from S:00 to S:03
- Level of sound is increased

Machine's power must be off to exit voice control mode

The last voice level that user determined before must be stored in memory.

For A4 series: Press “**Icon to the left of lower basket**” for 3” to change voice level. Increase level by pressing upper basket, decrease level by pressing lower basket.

6 SERVICE TEST

Only service can execute this procedure.

- Power OFF; press Start/Stop button and keep it pressed.
- For all models: Power ON by pressing On/Off button and still keep pressing Start/Stop button at least for 6”.
- When “Service test” is recognized
 - **For models w/o display:** All leds are ON.If model has sliding dispenser, all leds blink three times and service test starts.
 - **For models w/ display:** All leds are ON, SP is visualized on display and service test starts. During the first 6” of test, if a failure code is stored in memory, its codification blinks. Also at the end of the test if an error occurs its error code blinks.

During the test, SP is shown.

Step		Time	Tested Load
0	Show code	6”	Before start, the code of last error is visualized (see below)
1	Drain	6”	Drain pump.
2	Fill (3l/2,5l)*	~ 1’	Flow meter; Inlet Valve;
3	Fill + Wash (0,5/1lt)**		Flow meter; Inlet Valve; Pressure Switch;
4/	Turb. Sensor	30”	Measure of turbidity sensor
5	Wash	1’	Circulation pump; Regeneration Valve; detergent dispenser.
6	Wash + Heat ***	5’	Heater (PSW); NTC; diverter (position).
7/8	Reg. Valve + Turbo Fan	1’	Regeneration Valve + Turbo Fan
9	Water V+Drain	1’20”	Water Valve; Drain pump; Pressure switch
10	Drain	20”	Drain pump; pressure switch.
11	End	-	Code error or end led

* 3lt in A1; 2,5lt in A2.

** 0,5lt in A1; 1lt in A2.

*** In service test the unsuccessful heating failure routine works with reduced time of recognize (first measure at 2’20”, second measure t 4’20”)

Note: After that, If the PSW is OFF position, take 3 lt more and if the PSW turns ON, at the end of service program “EE” failure is shown.

Service Test for the models with 2nd water recovery tank;

Step		Time	Tested Load
0	Show code	6”	Before start, the code of last error is visualized (see below)
1	Fill3	180”	SGK2 Valve
2	Drain	Empty + 20”	Drain pump. Pressure Switch, Circulation pump (If SGK2 tank is filled)
3	Fill (3,5lt)	~ 1,5’	Flow meter; Inlet Valve, SGK2 Valve
4	Fill3	120”	SGK2 Valve
5/	Turb. Sensor	30”	Measure of turbidity sensor

6	Wash	1'	Pressure Switch; Circulation pump; Regeneration Valve; detergent dispenser.
7	Wash + Heat ***	5'	Heater (PSW); NTC; diverter (position).
8/9	Reg. Valve + Turbo Fan	1'	Regeneration Valve + Turbo Fan + SGK2 valve
10	Water V+Drain	1'20"	Water Valve; Drain pump; Pressure switch
11	Fill3	120"	SGK2 Valve
12	Drain	20"	Drain pump; pressure switch.
13	End	-	Code error or end led

If during the service test, the door is opened, Start/Stop led blinks (for models w/ display "SP" is shown).

If during the service test, the Start/Stop button is pressed, the program corresponding on the program leds(for models w/o display) or display(for models w/ display) position starts.

To reset the service test, press On/Off button or plug out and then plug in.

Also at the end of the test, if an error does not occur, any error code is not visualized. Machine will be standby position.

Note: If user did not set water hardness level before service test, "SE" is shown at the beginning and end of service test.

6.1 SERVICE FAILURE CODES

For models w/o display (A15);

Name	S_P	Wash	Dry	End	display	Notes	Error Explanation (for app)
Overflow/Leakage	-	Blink	-	Blink	F0/F1	In the normal work only leakage is visualized.	water leakage (F0 is not shown to user, shown in service test) F1 is shown to user
Drain time out	Blink	-	-	Blink	F2		unable to drain
Presence Flow meter impulses	-	-	-	Blink	F3		overflow of water
Absence Flow meter imp.	-	Blink	-	-	F4	In the normal work is not visualized.	flowmeter sensor (not shown to user, shown in service test)
Empty Level	Blink	-	-	-	F5		not enough water
Empty Level	-	-	Blink	-	FF	FF will be shown for new models (26.04.2020)	not enough water
Re-Fill time out	Blink	-	-	-	F5		not enough water

NTC ca/cc	Blink	Blink	-	-	F6		temperature sensor
Overheating	Blink	-	Blink	-	F7		overheating
Unsuccessful heating	-	Blink	Blink	-	F8	In the normal work is visualized at the end of prg	unable to heat (not shown to user, shown in service mode)
Turbidity Sensor	Blink	-	Blink	Blink	FA	In the normal work this failure is not visualized.	turbidity sensor (not shown to user, shown in service mode)
Parameter set salt incorrect	Blink	Blink	-	Blink	SE	In the normal work this failure is not visualized.	salt parameter not set (not shown to user, shown in service mode)
CK Parameters	Blink	Blink	Blink	Blink	FE	not used	-
HIGH VOLTAGE	Blink	Blink	Blink	-	HI		high voltage
LOW VOLTAGE	-	Blink	Blink	Blink	LO		low voltage
Auto Door	-	-	-	-	FC	In the normal work this failure is not visualized.	auto-door error (not shown to user, shown in service mode)
Incompatible Electronic Cards	-	-	-	-	EnA	In the normal work this failure is not visualized.	Incompatible main – display cards (not shown to user, shown in service mode)
2nd SGK valve failure	-	-	-	-	EE	In the normal work this failure is not visualized.	2nd SGK valve failure (not shown to user, shown in service mode)

For models w/ display;

Name	DISPLAY	Notes
Overflow	F0	In the normal work this failure is not visualized.
Leakage	F1	
Draining time out	F2	
Presence of Flow meter impulses	F3	
Absence of Flow meter	F4	In the normal work this failure is not visualized.
Empty Level	F5/FF	FF will be shown for new models (26.04.2020)
Re-Fill time out	F5	
NTC ca/cc	F6	
Overheating	F7	
Unsuccessful heating	F8	
Diverter opened	F9	
Turbidity Sensor	FA	In the normal work this failure is not visualized.
Parameter set salt incorrect	SE	In the normal work this failure is not visualized.
CK Parameter	FE	
High Voltage	HI	In the normal work this failure is not visualized.
Low Voltage	LO	In the normal work this failure is not visualized.

Wifi connection failure	1F	In the normal work this failure is not visualized.
Incompatible Electronic Cards	EnA	In the normal work this failure is not visualized.

2nd SGK valve failure	EE	In the normal work this failure is not visualized.
------------------------------	----	--

7 FAILURE ROUTINES

N°	Name	Exit of failure state	Service Call
1	Switch door open	Door closing	NO
2	Delay after door closing	7" delay before restart prg in heating step	NO
3	Overflow	Overflow signal gets off	NO
	Leakage	OFF/ON	YES
4	Draining time out	OFF/ON	YES
5	Presence of Flow meter impulses	Flow Meter signal gets off.	NO
		OFF/ON.	YES
6	Absence of Flow meter impulses	Pressure switch on Full.	NO*
		Pressure switch on Empty. OFF/ON	NO/YES
7	Level Empty	Level doesn't reach full	NO/YES
8	Re-Fill	3 Re – fill in the same washing step	NO/YES
8	NTC ca/cc	OFF/ON	YES
8	Overheating	OFF/ON	YES
10	Unsuccessful heating	OFF/ON	YES
11	Diverter opened	OFF/ON	YES
12	CK Parameters	OFF/ON	YES
13	High Voltage Failure	OFF/ON	YES
14	Low Voltage Failure	OFF/ON	YES

*Cycle could be executed with a filling time.

Failure Routine

If a failure is recognized:

- Stop all devices
- Stop program flow.
- Drain Empty + 30" with circulation pump on

If the failure requires the termination of the washing program:

- Stop all the devices.
- Start to visualize the failure code.

If the failure doesn't require the termination of the washing program:

- Stop all the devices.
- Re-Start the washing program.

If it is necessary it performs the *Re-Fill routine*

Re-Fill Routine:

After a forced drain (ex: a failure routine) if the dishwasher was in wash before the drain it performs the re-fill routine:

- Inlet Valve ON + circulation pump OFF to load 3l (time out 420")
- When the first load step is finished, Inlet Valve ON + circulation pump ON to load 1l (time out 100")
- Return to the washing cycle

Re-Fill Routine for the models with 2nd water recovery tank:

After a forced drain (ex: a failure routine) if the dishwasher was in wash before the drain it performs the re-fill routine:

- Inlet Valve ON + SGK2 valve ON, circulation pump OFF to load 4l (time out 520")
- SGK2 valve ON for 120" (Fill 3)
- Return to the washing cycle

7.4 DESCRIPTION OF FAILURES

Opened door switch

Recognize: if door is opened with a started program
 Action Wait
 Exit Closing door.
 Service No

Model	Start/Stop(w/o display) Delay(w/display)	Wash	Rinse	Dry	End	Display
A1	Blink	-	-	...
A2	Blink	-	-	-	-	...

Delay in re-start program

Recognize: if door is opened and re-closed in a heating step.
 Action Wait 5" before restart program.
 Exit Closing door.
 Service No

Overflow/Leakage

Recognize: 5" with overflow pressure sensing = on.
 Action Go to Failure routine.
 Exit If overflow signal gets off until failure routine finishes (cause is overflow): washing program restarts.
 It re-fills water according to Re-Fill routine and it continues to wash.
 Service If overflow signal persists until failure routine (cause is leakage): OFF/ON.
 NO if overflow. YES if leakage

Only for leakage

Model	Start/Stop(w/o display) Delay(w/display)	Wash	Rinse	Dry	End	Display
A1 w/o display	-	Blink	-	-	Blink	... (F1)
A1 w/ display,A2	All leds blink					F1

Draining timeout

Recognize: 180" with drain pump ON and circulation pump ON with pressure sensing in full level position.
 Action Go to Failure routine
 Exit OFF/ON
 Service YES

Model	Start/Stop(w/o display) Delay(w/display)	Wash	Rinse	Dry	End	Display
A1 w/o display	Blink	-	-	-	Blink	... (F2)
A1 w/ display,A2	All leds blink					F2

Model	Start/Stop(w/o display) Delay(w/display)	Wash	Rinse	Dry	End	Display
A1 w/o display	Blink	-	-	...(F5)
A1 w/ display,A2	All leds blink					F5

For new models (26.04.2020)	Start/Stop(w/o display) Delay(w/display)	Wash	Rinse	Dry	End	Display
A1 w/o display	-	-	-	Blink ...	-	...(FF)
A1 w/ display,A2	All leds blink					FF

Level Empty and rarely Flow meter impulses

Recognize: With rarely flow meter impulses (time out of absence of flow meter impulses doesn't expire) it doesn't reach the first quantity of required water (2,5l) within the time out (420")

Action Go to Failure routine.

Exit OFF/ON

Service Not necessary if the reason is a momentary. YES in the other cases.

Model	Start/Stop(w/o display) Delay(w/display)	Wash	Rinse	Dry	End	Display
A1 w/o display	Blink	-	-	...(F5)
A1 w/ display,A2	All leds blink					F5

Recognize: With rarely flow meter impulses (time out of absence of flow meter impulses doesn't expire) it doesn't reach the second quantity of required water related to the washing cycle) within the time out (100")

Action Go to Failure routine.

Exit OFF/ON

Service Not necessary if the reason is a momentary. YES in the other cases.

Level Empty and regular/rarely Flow meter impulses

Recognize: With flow meter impulses (time out of absence of flow meter impulses doesn't expire) it reaches the second quantity of required water related to the washing cycle) but it doesn't reach the full level within the time out (30")

Action Go to Failure routine.

Exit OFF/ON

Service Not necessary if the reason is a momentary. YES in the other cases.

Model	Start/Stop(w/o display) Delay(w/display)	Wash	Rinse	Dry	End	Display
A1 w/o display	Blink	-	-	...(F5)
A1 w/ display,A2	All leds blink					F5

Re-Fill

Recognize: During a washing step, if pressure switch goes from full level to empty level Failure routine start.
Wash restarts with the Re-Fill routine (3l+1l).
If pressure switch goes from full level to empty level for 3 times during the same washing step failure is recognized.

Model	Start/Stop(w/o display) Delay(w/display)	Wash	Rinse	Dry	End	Display
<i>A1 w/o display</i>	Blink	-	-	...(F5)
<i>A1 w/ display,A2</i>	All leds blink					F5

NTC open or short-circuit

Recognize: Recognition of open or short-circuit NTC (-20°C/86°C). Test is executed during all the program flow.

Action Go to Failure routine.

Exit OFF/ON

Service YES

Model	Start/Stop	Wash	Rinse	Dry	End	Display
<i>A1 w/o display</i>	Blink	Blink	-	-	-	...(F6)
<i>A1 w/ display,A2</i>	All leds blink					F6

Overheating

Recognize: Water temperature $\geq 77^{\circ}\text{C}$. The test is done during all the cycle.

Action Go to Failure routine.

Exit OFF/ON

Service YES

Model	Start/Stop(w/o display) Delay(w/display)	Wash	Rinse	Dry	End	Display
<i>A1 w/o display</i>	Blink	-	-	Blink	-	...(F7)
<i>A1 w/ display,A2</i>	All leds blink					F7

Unsuccessful heating

Recognize: During the heating phases, after the first 420", if water temperature increases less than 2°C or if it is less than 0°. The first valid value to check is read after 120" from the beginning of the heating step.

The test is executed only if the measured temperature is lower than 60°. After door opened and reclosed during heating, temperature and time value which are read before door is opened must be cleared. Also, the control routine will start from beginning of failure routine.

Action Skip the heating step. The test is repeated in all the heating steps. If in a following step, the heating is OK the failure is cleared. The failure is shown at the end of the program.

Exit OFF/ON

Service YES

Model	Start/Stop	Wash	Rinse	Dry	End	Display
<i>A1 w/o display</i>	-	Blink	-	Blink	-	...(F8)
<i>A1 w/ display,A2</i>	All leds blink					F8

Note: F8 is not sensed and shown in Jetwash 14' program.

Diverter Open Circuit(only A2)

Recognize: 30" with motor of diverter valve ON and diverter sensing doesn't change

Action Go to Failure routine.

Exit OFF/ON

Model	Start/Stop	Wash	Rinse	Dry	End	Display
A2	All leds blink					F9

Turbidity (A2)

Model	Start/Stop	Wash	Rinse	Dry	End	Display
A2	All leds blink					FA

Voltage failure

Recognize: If the card detect high or low voltage level from main supply
Action: Stop the program . After 3 hours Go to Failure Rutine and show failure code.
Exit: OFF/ON
Service: YES

High Voltage Failure: When high voltage (for 220V models above 285V, then 275-285VAC; for 110V models, above 145V, then 135-145VAC) detected during 3 hours

Model	Start/Stop(w/o display) Delay(w/display)	Wash	Rinse	Dry	End	Display
A1 w/o display	Blink	Blink	-	Blink	-	...
A1 w/ display,A2	All leds blink					HI

Low Voltage Failure: When low voltage (blow 145V, then 145-155VAC) detected during 3 hours [Low voltage failure is not available for 110V models]

Model	Start/Stop(w/o display) Delay(w/display)	Wash	Rinse	Dry	End	Display
A1 w/o display	-	Blink	-	Blink	Blink	...
A1 w/ display,A2	All leds blink					LO

Parameters Set Incorrect

Recognize: When parameter Set Salt is uncorrected
Action: Go to Failure routine.
Exit: OFF/ON
Service: NO

Model	Start/Stop(w/o display) Delay(w/display)	Wash	Rinse	Dry	End	Display
A1 w/o display	Blink	Blink	-	-	Blink	...(SE)
A1 w/ display,A2	All leds blink					SE

Parameters Check Sum

Recognize: When parameter Check sum is uncorrected
Action: Go to Failure routine.
Exit: OFF/ON
Service: The problem would disappear after switch OFF/ON of the dishwasher. If it doesn't disappear YES.

Model	Start/Stop(w/o display) Delay(w/display)	Wash	Rinse	Dry	End	Display
<i>A1 w/o display</i>	Blink	Blink	-	Blink	Blink	...

<i>A1 w/ display,A2</i>	All leds blink				FE
-------------------------	----------------	--	--	--	----

Auto Door Failure

Recognize: When auto door mechanism is activated, the door is not opened
 Action: Go to Failure routine.
 Exit: OFF/ON
 Service: NO

Model	Start/Stop(w/o display) Delay(w/display)	Wash	Rinse	Dry	End	Display
<i>A2</i>	All leds blink					FC

Wifi connection failure

Recognize: When the wifi cable between display board and wifi board is disconnected.
 Action: -
 Exit: -
 Service: YES

Model	Start/Stop(w/o display) Delay(w/display)	Wash	Rinse	Dry	End	Display
<i>A series with display</i>	All leds blink					1F

Incompatible Electronic Cards failure

Recognize: There is a communication failure between mainboard and display card. One or both of the cards are incompatible.
 Action: -
 Exit: -
 Service: YES

Model	Start/Stop(w/o display) Delay(w/display)	Wash	Rinse	Dry	End	Display
<i>A series with display</i>	All leds blink					EnA

2nd SGK valve failure

Recognize: The 2nd (new) water recovery tank (SGK) valve is not working.
 This failure is saved to the memory and shown on the service program.
 It is saved for only during Eco and Save 5.4lt programs.
 It is saved on the following situation;

- Flowmeter is ON during water taking from 2nd tank (0,7lt water inlet step + SGK2 Valve is on),
- PSW is OFF at the 10" PSW check step (PSW check),
- 4' water taking from 1st tank (Fill 2)
- PSW is ON at the 10" PSW check step
- If the above behaviours done, the EE failure is saved to the memory.

Model	Start/Stop(w/o display) Delay(w/display)	Wash	Rinse	Dry	End	Display
<i>A series with display</i>	All leds blink					EE

7.5 FAILURE CODES

Coding failure for models without display:

Name	S_P	Wash	Dry	End	display	Notes
Overflow/Leakage	-	Blink	-	Blink	F0/F1	In the normal work only leakage is visualized.
Drain time out	Blink	-	-	Blink	F2	
Presence Flow meter impulses	-	-	-	Blink	F3	
Absence Flow meter imp.	-	Blink	-	-	F4	In the normal work is not visualized.
Empty Level	Blink	-	-	-	F5	
Empty Level	-	-	Blink(FF)	-	FF	FF will be shown for new models. (26.04.2020)
Re-Fill time out	Blink	-	-	-	F5	
NTC ca/cc	Blink	Blink	-	-	F6	
Overheating	Blink	-	Blink	-	F7	
Unsuccessful heating	-	Blink	Blink	-	F8	In the normal work is visualized at the end of prg
Parameter set salt incorrect	Blink	Blink	-	Blink	SE	In the normal work this failure is not visualized.
CK Parameters	Blink	Blink	Blink	Blink	FE	
HIGH VOLTAGE	Blink	Blink	Blink	-	HI	
LOW VOLTAGE	-	Blink	Blink	Blink	LO	
Incompatible Electronic Cards	N/A	N/A	N/A	N/A	EnA	This failure is not applicable for models without digit.
2nd SGK valve failure	N/A	N/A	N/A	N/A	EE	This failure is not applicable for models without digit.

Coding failure for models with display:

N°	Name	S/P	Display	All leds
1	Door open	Blink	-	
2	Delay before Door closing	-	-	
3	Overflow Leakage	-	-	
		-	F1	Blink
4	Drain time out	-	F2	Blink
5	Re-Fill time out		F5	Blink
6	Presence Flow meter imp.		F3	Blink
7	Absence Flow meter imp. With Full		-	

Graphics Card Communication Error

Action: The error is shown on the screen when the machine is turned ON.

Root Cause of Failure:

- i) When the communication line between the motherboard and the graphics card is open (the motherboard or the graphics card connector is not inserted properly)
- ii) When motherboard and graphics card software versions are not compatible to work with each other

Model	To show
<i>A series , S series and T3-T4 models with display</i>	EnA

Troubleshooting Steps:

- 1- Unplug the product, wait at least 3 seconds and then plug it in. Power up the machine and check if the problem is solved.
- 2- Make sure that the sockets connecting the graphics card and motherboard are placed correctly. Power up the machine and check if the problem is solved.
- 3- Replace the motherboard with a different motherboard with the appropriate software. Power up the machine and check if the problem is solved.
- 4- Replace the graphics card with a different graphics card with the appropriate software. Power up the machine and check if the problem is solved.

	Absence Flow meter imp. Without Full		F5/FF(for new models, 26.04.2020)	Blink
8	NTC ca/cc		F6	Blink
9	Overheating		F7	Blink
10	Unsuccessful heating*		F8	Blink
11	Diverter opened		F9	Blink
12	CK Parameters		FE	Blink
13	Parameter set salt incorrect		SE	Blink
14	Turbidity Sensing		FA	Blink
15	Auto Door Failure		FC	Blink
16	High Voltage Failure		(HI)	Blink
17	Low Voltage Failure		(LO)	Blink
18	Incompatible Electronic Cards		(EnA)	Blink
19	2nd SGK valve failure		(EE)	Blink

8 END TEST

End test is divided in two parts: end test 1 (functionally test) and end test 2 (heating and leakage test).

End test 1:

Vestel receives the electronic cards ready to start “end test 1”. In any case, it’s possible, re-start the end test 1 with a manual manoeuvre.

- Power ON and immediately press related buttons as written below for 3”.

Press up and down buttons for models without display. Press

Program and Delay buttons for models with display.

For A4 models, press lower basket touch button.

- When “End test 1” is recognized

- **For models w/o display:** All leds are ON and then all leds are ON(salt and rinse aid leds are ON if there is no salt and rinse aid)
- **For models w/ display:** All leds are ON, EP is shown on display and then all leds are ON,888 is shown on display

-After end test starts, All digits and all leds should be on together at the beginning of the end test-1 (display also show 888) during first 3 seconds.

- 188 Display segments are activated after the detergent dispenser.

-During end test 1, display shows “1:EP”.



- At the end of end test 1, switch OFF the dishwasher.

-To skip the End test1, press Start/Stop button for 3 sec.

Diverter failure: Stop circulation pump just after detergent dispenser activation at step 41 until the end of program if electronic card cannot detect diverter position during end test 1.

Turbidity failure: Start circulation pump just after turbidity sensor check (at step 92) for 6 sec, if electronic card realize

Turbidity sensor failure during turbidity test.

If we open/close the door during end test, End test continues from the point on which we open/close the door. End test combinations keep performing.

-Salt indicator and rinse aid indicator is ON if reed sensors are short cut during end test END TEST 1 or END TEST2

-Salt indicator and rinse aid indicator is OFF if reed sensors are not short cut during end test END TEST 1 or END TEST

Note: In cases where the machine is energized, On/Off led is ON.

However, there is a special case such that if On/Off led does not exist in model codification, the led is OFF. If the led is included in the codification, On/off led is ON. After codification ended, On/Off led is ON since machine is energized.

End test 2

When the electronic card is switched on after the end test 1, end test 2 starts.

- 4" of pause
- Heating to reach 62°C with 13' of time out
- Only circulation pump is on for 10" sec
- Drain + Regeneration valve is on 20"
- End test 2 is finished.

During this phase, failure routine of unsuccessful heating and failure routine of NTC works. If the water temperature doesn't increase, at the end of 15', the drain pump will be on.

When the electronic card is switched on after end test 2, it will be in washing mode.

-During end test 2, display shows "2:EP".



At the end of end test 2, machine turns to standby position(Eco program is shown as default).

Note: During check of Turbidity and Diverter position in the End Test1, if there occurs error, electronic card will save these errors and will go to the failure routine at the beginning of END test 2 (as NTC failure recognition)

End test 3

<

In software with wifi that will come after 15.10.2020, End test 3 will behave as follows in common with wifi.

- In end test 3, ping test is not performed, only all leds light up.
- When the mains power is cut and restored while in ET3, the machine starts from ET3 again.
- When the machine is in end test 3, when any button is pressed, it exits and gets ready.

>

When the electronic card is switched on after the end test 2, end test 3 starts and display shows "3:EP". During ET3, all leds are on.



- During end test 3, if user open the door, end test 3 is going on to be performed.
- During ET3, if mains power is cut and machine energized again with plug in, ET3 restarts.
- When any button is pressed including on/off button, ET3 will be end and machine will go to ready state.

9 SECRET COMBINATION TABLE

		A1 w/o disp	A1 w/disp	A2	A3	A4
Favorite select		up 3"	program 3"	program 3"	program 3"	favorite icon press once
	If it has wifi	up 3"	program+delay press simultaneously	program+delay press simultaneously	program+delay press simultaneously	favorite icon press once
Favorite save		up+down press simultaneously	program+delay press simultaneously	program+delay press simultaneously	program+delay press simultaneously	favorite icon immediate touch 3"
	If it has wifi	up+down press simultaneously	Program + tablet 1"	Program + select 1"	Program + select 1"	favorite icon immediate touch 3"
voice set up		-	half load+ tablet 3" (+) half load (-) tablet	options+select 3" (+) option (-) select	options+select 3" (+) option (-) select	Icon to the left of Lower basket 3" (+) Upper basket (-) lower basket
Inner light		up+half load 3"	program+half load 3"	program+options 3"	program+options 3"	lower basket 3"
Ion Tech		down 3"	half load 3"	options 3"	options 3"	HL (Upper basket) 3"
UVON Tech		-	-	options 6"	options 6"	HL (Upper basket) 6"
Config	If it has wifi	delay 3"	delay+tablet 3"	Delay + Select 3"	Delay + Select 3"	left down side + right down side (3 sec)
Wifi activation/de activation	If it has wifi	half load 3"	program 1.8"	program 1.8"	Program 1.8"	remote icon (phone symbol)
(remote control)						press once

ADO Control Test		Energy Save (hold) -> power on -> Energy Save 3"	Half Load (hold) -> power on -> Half Load 3"	Options (hold) -> power on -> Options 3"	Options (hold) -> power on -> Options 3"	Energy Save (hold) -> power on -> Energy Save 3"
BLDC Control Test				power on->select 3" (+) option (-) select	power on->select 3" (+) option (-) select	power on->upper basket 3" (+) upper basket (-) lower basket
water hardness		power on->up 3" (one beep)	power on->program 3" (one beep)	power on->program 3" (one beep)	power on->program 3" (one beep)	power on->delay 3" (one beep)
rinse aid		power on->up 5" (double beep)	power on->program 5" (double beep)	power on->program 5" (double beep)	power on->program 5" double beep)	power on->delay 5" (double beep)
service test		power on->S/P 6"	power on->S/P 6"	power on->S/P 6"	power on->S/P 6"	power on->S/P 6"
end test		power on->up+down 3"	power on->program+delay 3"	power on->program+delay 3"	power on->program+delay 3"	power on->lower basket 3"
Water save control				power on->options + select 6"	power on->options + select 6"	Power on -> Ext. DRY 3"

A1E





*For A4 models Wifi icon does not have touch sense feature; Remote icon has touch sense feature.

10 Wifi Specifications

Valid from 15.10.2020, on the wifi models;

- For the automatic ping test in production; at the first energizing, machine broadcasts wifi for 10 minutes. During ET2 wifi modul energy is cut, wifi does not broadcasting on ET2 mode. When it switches to ET3, it continues to count the 10 minutes from where it left off.
- When the machine is in End test 3, if any button is pressed, machine goes to the ready state.
- The machine broadcasts for 10 minutes after config buttons are pressed and CF is seen on the screen. After config buttons are pressed, only wifi led blinks during broadcasting.
- If the wifi setup is not completed after pressing the config buttons once on the machine and CF is seen on the screen, the wifi leds are off when the machine is turned off and on.
- If wifi is configured on the machine, the wifi led lights up continuously. When the remote is activated, the remote led lights continuously.
- If the modem connection is established within 30 seconds after the machine is turned off and on after the installation, the wifi led lights up as soon as the connection is established. If the time to connect to the modem is longer than 30 seconds, after 30 seconds, the wifi and remote leds will blink until the modem connection is established. When the machine is reconnected to the modem, the wifi led lights up continuously, the remote led does not light up.
- If the modem is disconnected while wifi is configured, the wifi and remote leds will blink until it is reconnect.
- If the remote is deactivated after configuration, the machine turns off after 15 minutes. If the remote is active, the machine does not turn off after 15 minutes, the screen is turned off and only the wifi and remote leds turn on. The machine wakes up when intervention is made on the machine or from the application.
 - After configuration, remote control may appear as active. (It depends on which statues left of the same wifi board on the previous connection)

Config buttons

For A1 with digit, A2, A3 with Wi-Fi models, press blue indicated buttons shown on the below panel for 3 seconds.



For A4 with Wi-Fi models, press blue indicated buttons shown on the below panel for 3 seconds.

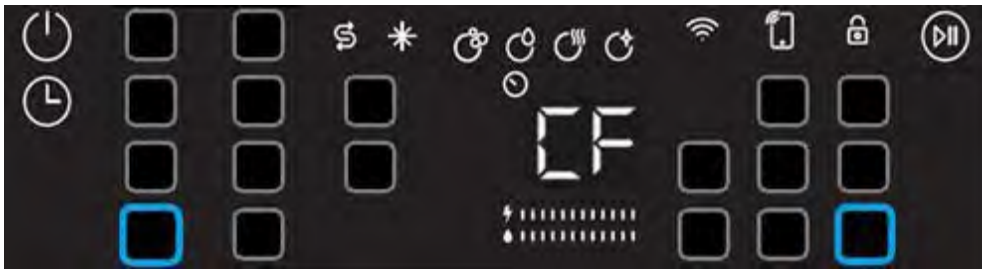

At the end of 3 seconds CF will be shown on the display.

	After End Test 3, in all turning on without pressing the config buttons	After pressing the config buttons	In off-on status after pressing Config buttons	After connection (without activating Remote)	After the remote is activated	If machine is turned off and on after connection (with or without Remote activation)	
						If modem is connected within 30 seconds after machine is turned on.	If modem is not connected within 30 seconds after machine is turned on.
Wifi Led	No	Yes, as blink for 5 min.	No	Yes, continuously	Yes, continuously	Yes, continuously after connection	After 30 seconds, it will blink until modem is connected. When modem is connected, the wifi led turns on continuously.
Remote Led	No	No	No	No	Yes, continuously	No	After 30 seconds, it will blink until modem is connected.
Wifi broadcast	Yes, for 10 min.	Yes, for 10 min.	Yes, for 10 min.	No	No	No	No

Remote Control buttons

For A1

Press 2 sec.
for remote
control.

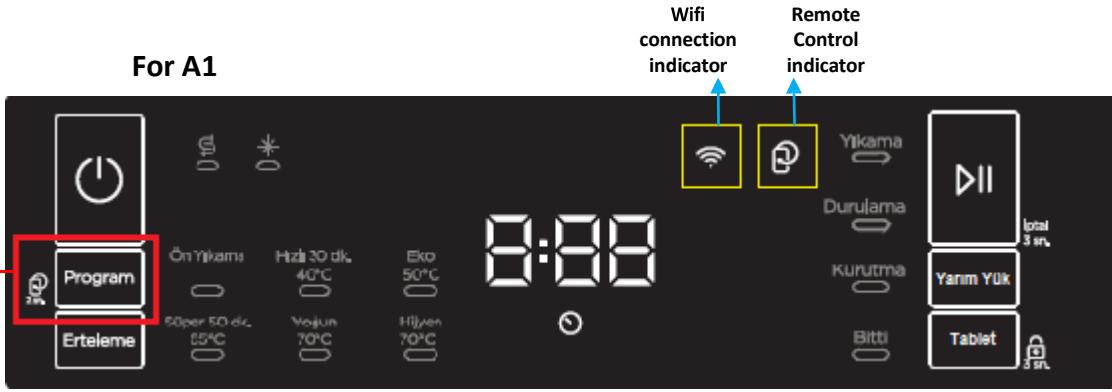

For A2,A3

Press 2 sec.
for remote
control.

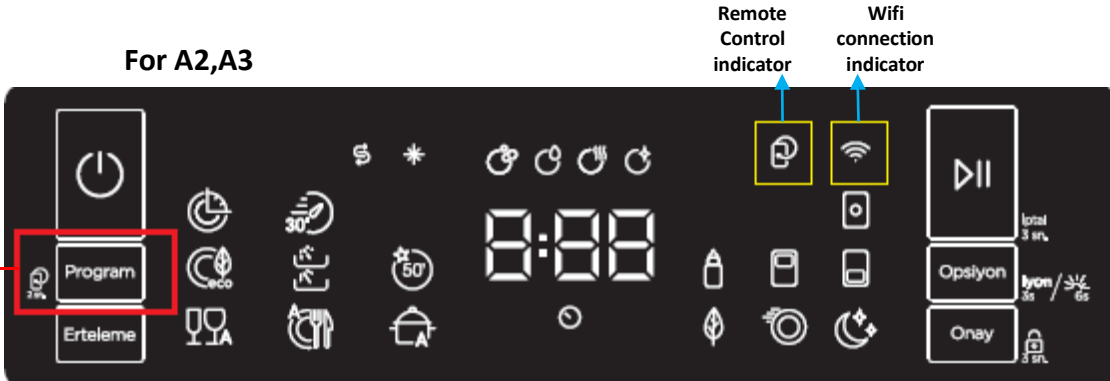

For A4

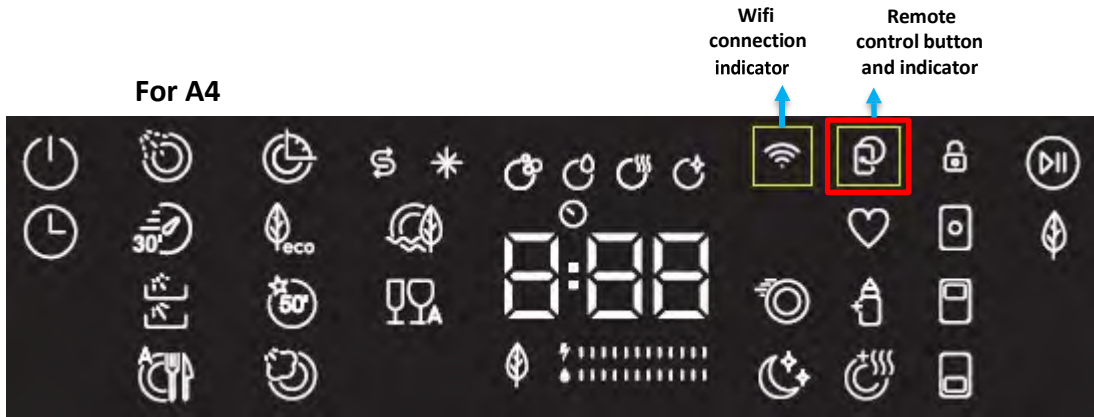

Device panel selection images on the app:

EVIN AKLI: A1E:



A25:



A34:



A45:



SHARP: A1E:



A25:



A34:



A45:



VEEZY: A1E:



A25:



A34:



A45:



LED BEHAVIOURS			
Mode	Wifi Led	Remote Control Led 	Note
Not configged for the first time	OFF	OFF	Before CONFIG button combination is pressed at the first time
Wifi configuration step	BLINK	OFF	After CONFIG button combination is pressed, WIFI of machine is active, ready for connection to modem. Shows that user is in the connection step. 5 minutes after Config button combination pressed, if product does not connected to any modem, Wifi led turns OFF, and Not Configged mode is ON.
RC (remote control)active	ON	ON	product connected to modem, remote control active
RC inactive (Config completed)	ON	OFF	product connected to modem, remote control inactive
Internet lost when connected	BLINK	BLINK	After the connection is set up and RC is ON; this beaviour happens; 1)if the internet of the dishwasher is lost (If internet comes again, RC ACTIVE mode will be ON) or, 2)if the power of the machine is ON again after a power loss (If the connection is succeeded, RC INACTIVE mode is ON)

Security related Wifi controls:

- 1) If config operation is done, when the program is started, RC is automatically activated (no need to activate the RC by pressing the button on control panel)
(not valid if the program is started when the door is open)
- 2) RC becomes OFF;
 - when the door is opened
 - when the machine is turned off and on
 - if the energy of the machine is lost because of the loss of line
- 3) When the door is open;
 - RC cannot be activated

WIFI SLEEP mode:

While RC is ON;

- Machine does not turn off automatically (even in ECO MODE). The screen goes to WIFI SLEEP mode 15 minutes after the ready state or 15 minutes after the program finished.

During wifi sleep mode;

- If there is internet; only WIFI+ RC icons/leds are ON, all other leds are OFF.
- If the internet connection of the machine is lost in this mode, WIFI SLEEP mode continues, only WIFI+RC icons blink until the internet is connected again.

Evin Akli Mobile Application;

- 1) When Config is ON and RC is OFF, machine can be remotely monitored, which means machine can not be controlled from the application, but status of the machine can be monitored on the application.
- 2) When ionizer is activated on the machine, it can be seen on the application with a notification. The ionizer function can be cancelled on mobile application.

11 HARDWARE CONTROLS

11.1 BM05 TYPE MAINBOARD

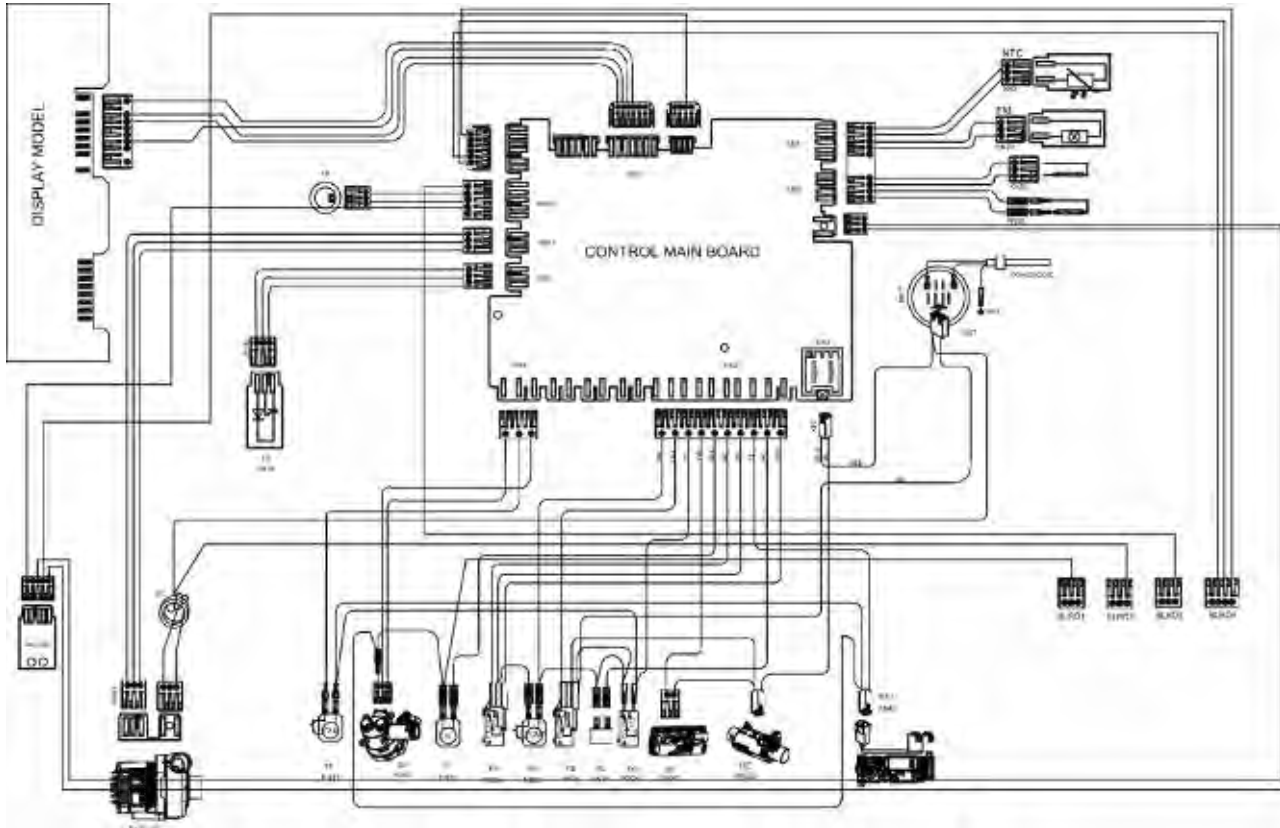

Note: valid after 04.12.2020, for A1 models, the ionizer module (220V) will be driven with the T710 triac (in order to combine with double-winding).

Except asynchronous with Autodoor, for A2, A3, A4 models, the ionizer module will continue to be driven from the triac, "T711". (For asynchronous with/or Autodoor and Double Windings models of these series, the pin details are indicated in the section 11.4)

PIN	PIN OUT	COMPONENT
CN11.1	+7V transistor	Ionizer mini fan, dc main fan, uv led

CN11.2	+7V transistor	Ionizer led, infoled 2 led 1
CN11.3	+7V transistor	Dc lightening
CN11.4	-5V	Common ground
CN11.5	+7V	Sto motor

11.2 BM12 RELAY BOARD

Valid from 1.4.2020, for A series BLDC models; In case of driving with BM05rev4 card and BM12 relay card, BM12 card data control is done from BM05/CN12.2.

CN11					CN12					
1	2	3	4	5	1	2	3	4	5	6
Vo3	Vo1	Vo2	-5	7 sabit	-5	DSDA	Dscl	Oe2	Sw2	G
				blr3	blr4.3	blr4.2(data)				blr4.4

11.3 DC FAN

For slim models, DC fan is used and it is driven through the CN11.1 connector.

11.4 Asynchronous with Double Windings or Autodoor

- For Asynchronous with Double Windings models;

- T711 (CN14.1) is used for low RPM,
- T712 (CN3.3) triac is used for high (current) RPM.
- T710 (CN16.1) is used for Ionizer.

- For Asynchronous with Autodoor models;

- T711 (CN14.1) is used for Autodoor.
- T710 (CN16.1) is used for Ionizer.

- For Asynchronous models with Double Windings and Autodoor together;

- CN14.1 - T711 is used for Autodoor,
- CN6.2 - T703 is used for double winding low pin,
- CN16.1 - T710 is used for Turbo fan
- Ionizer can not be used on these models.

FAILURE CODES (Possible Problems)

F1 (ALARM IS ACTIVE FOR OVERFLOW)

FLOATER

- Floater switch can be out of order or have a problem with the cable connection.

TUB

- There can be a water leakage from the tub

ELECTRONIC CARD

- Electronic card can be out of order.

F2 (THE WASTE WATER IN THE MACHINE CANNOT BE DISCHARGED)

Drain hose

- Water outlet hose is clogged
- Check of the water outlet hose position.

Drain pump

- Check the drain pump resistance and power values
- There can be a problem with cable connection of the drain

Pressure switch

- Pressure switch of the heater casing group can have a mechanical or cable connection problem.

F3 (ERROR OF CONTINUOUS WATER INPUT)

Water inlet valve

- Water inlet valve can be out of order or can not be closed.

Electronic card

- Electronic card can be out of order.

F4 (FLOWMETER FAULTY)

Flowmeter

- Flowmeter can be out of order.
- Cable connection of flowmeter can be faulty.

Electronic card

- Electronic card can be out of order.

F5 (INADEQUATE WATER SUPPLY)

Water tap

- Make sure the water input tap is totally open and that there is no water cut.

Water inlet hose

- Close the water input tap, separate the water input hose from the tap and clean the filter at the connection end of the hose.

Water inlet valve

- Water inlet valve filter can be clogged.
- Water inlet valve can be out of order. There can be a problem with the cable connection of water inlet valve.

Floater

- Floater switch can be out of order or have a problem with the cable connection.

Pressure switch

- Pressure switch of the heater can have a mechanical or cable connection problem.

Circulation pump

- Circulation pump can be out of order or have a problem with the cable connection. External part can be blocked to the circulation pump.

F6 (NTC FAULTY)

Ntc

- Ntc can be out of order.
- Ntc cable connection can be faulty. Ntc can be short or open circuit.

Electronic card

- Check the power and resistance value of heater.
- Check the cable connection of the heater.
- There may be an explosion in the NTC triac region on the electronic card.
- The electronic card may be deformed.

CABLE HARNESS

- There may be a problem caused by the disconnection between the cable tree, NTC and electronic board.

NOTE: If the NTC part is faulty, it will not resist in any way.

F7 (EXTREME HEATING UP FAULTY)

Ntc

- If the water temperature inside machine higher than 77°C, ntc can be out of order.

Electronic card

- Electronic card can be out of order.

F8 (INADEQUATE HEAT)

Heater

- Check the power and resistance values.
- Check the cable connection of the heater.

Electronic card

- Check the electronic card

F9 (DIVERTER POSITION PROBLEM)

Diverter

- Check the values of the diverter.
- Check the cable connection of the diverter.

Electronic card

- Check the electronic card

FA (TURBIDITY SENSOR FAULTY)

Turbidity sensor

- There can be some soil around the turbidity sensor.
- Check the cable connection of the turbidity sensor.

Electronic card

- Check the electronic card.

2. ELECTRICAL COMPONENTS AND MEASUREMENTS

2.1. Door Lock:

It is a mechanical lock/release system that is closing the door, supplying the connection of electrical parts in the machine and cutting off the connection.

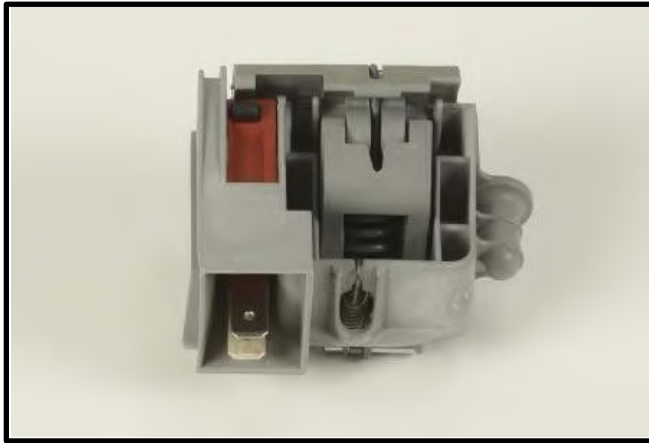

Current: 16 (4) A

2.2. Circulation Pump:

Voltage	220/240
Frequency	50HZ
Total Power	90W
Coil Isolation Class	F
Thermal Protector	150°C
Pump Outlet Pressure	300mbar
Pump Flowrate	60 lt/min

Measurement of the primary windings of the washing pump. (118.2-135.9 Ω)

Measurement of the secondary windings of the washing pump (white cable – blue cable) (117.9-135.6 Ω)

Motor specification: Single direction, single phase, asynchronous and two pole.

It is assembled to the basement with rubber hangers.



Measurement from the cable harness:

You can only measure the primary winding value from the electrical card.

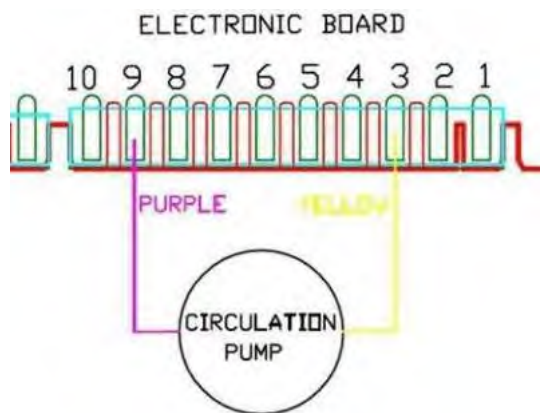

Above sketch show the connectors of the washing pump on the electrical card. Probes of the tester should be applied on to the related connectors.

Measurement from the component:

Measurement of the secondary windings of the washing pump (white cable – blue cable)



Measurement of the secondary windings of the washing pump (white cable – blue cable)



Probes of the tester should be applied on to the related connectors as shown on the pictures.

2.3. Circulation Pump Capacitor:

2,5 μ F - 450 V class S2

Capacitor is permanently connected to the circulation pump coils.

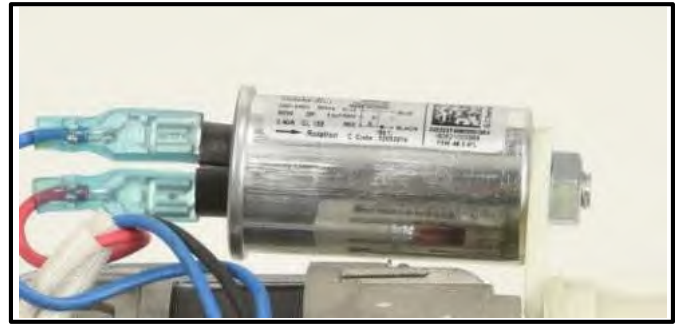

2.4. Drain Pump:



Voltage	220/240 volt
Frequency	50Hz
Flowrate	30W
Coil Resistance / Hanyu	220 Ω % \pm 7
Coil Resistance / Leili	141 Ω % \pm 7
Coil Isolation Class	F
Thermal Protector	120 $^{\circ}$ C

Measurement from electronic Card:

PUMP TYPE	RESISTANCE
DRAIN PUMP / HANYU	220 Ω % \pm 10
DRAIN PUMP / LEILI	141 Ω % \pm 10

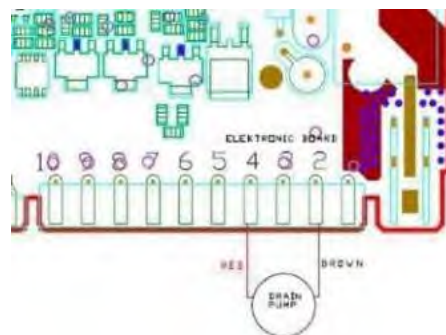

Above sketch show the connectors of the drain pump on the electronic card. Probes of the tester should be applied on to the related connectors.

Measurement from the component:



Probes of the tester should be applied on the related connectors as shown on the pictures.

2.5. Heater:

Voltage 220/240 volt

Total power 1800W

27.6-30.6 ohm

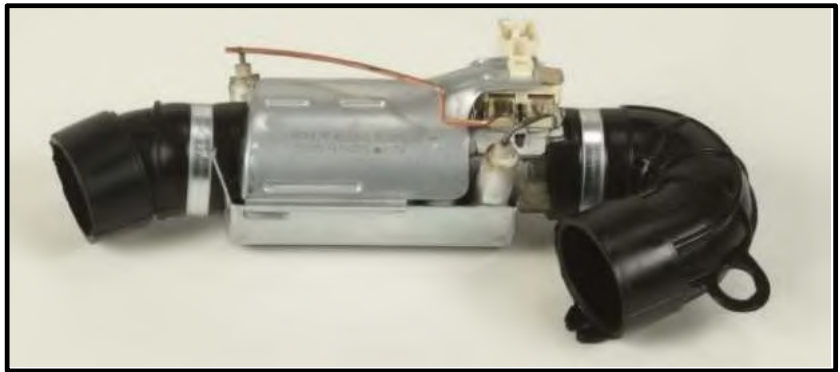

It can' be measured from the electronic card.

2.6. Ntc:

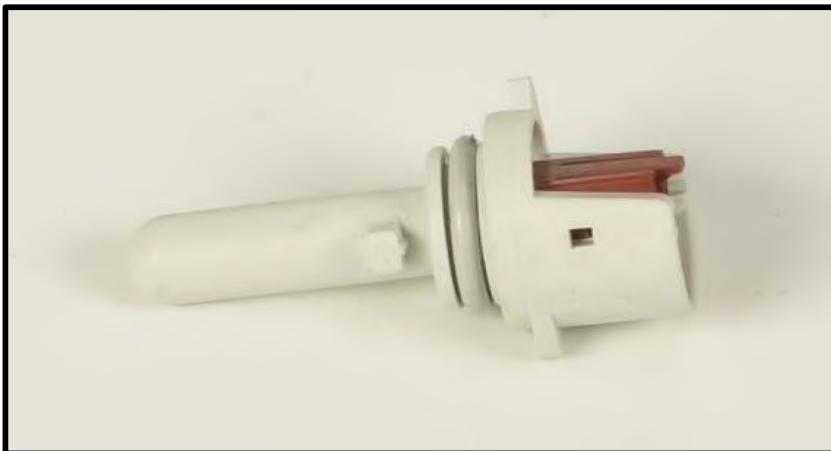

+25 °C	-	47.200	±	850	Ω
+30 °C	-	37.500	±	675	Ω
+40 °C	-	24.900	±	349	Ω
+50 °C	-	17.000	±	170	Ω
+60 °C	-	11.700	±	117	Ω
+70 °C	-	8.280	±	108	Ω
+80 °C	-	5.945	±	101	Ω

2.7. Pressure Switch:

Voltage 220/240 v

Frequency 50/60 Hz

16 A - 3 Pins

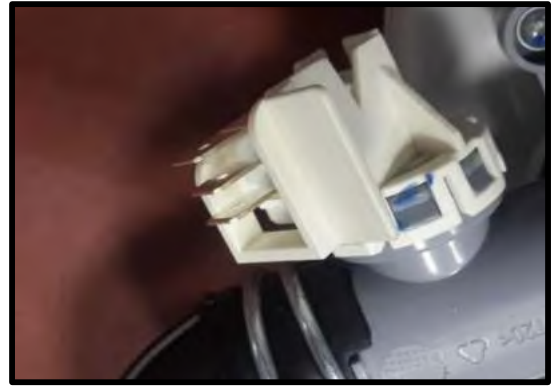

PRESSURE SWITCH	C		T		Full fill water & Circulation pump works
	CN2.10-CN2.2	$\infty \Omega$	KN2.9-KN2.10	$\infty \Omega$	
CN2.10-CN2.2	0Ω	KN2.9-KN2.10	0Ω		

Pressure switch on Aquazone:



2.8. Diverter:

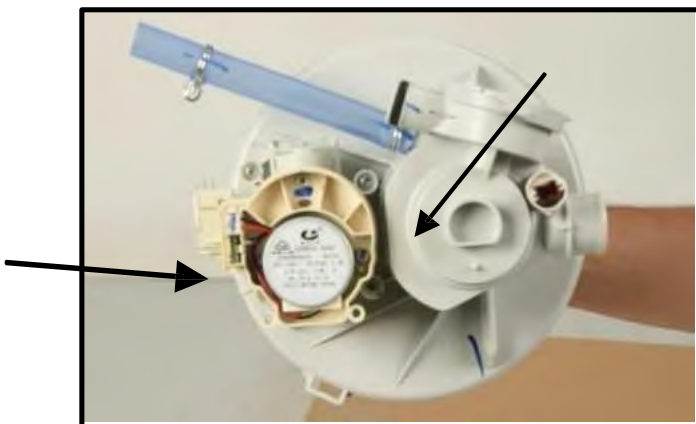

It is assembled to the heater sump group.

Voltage	220/240 V
Frequency	50 Hz
Power	8W
Resistance	$10500 \pm \%5 \Omega$

Measurement from the electrical Card:

	C	T
DIVERTER	CN 6.1 - CN 2.9 $10500 \pm \%7 \Omega$	KN 6.1 - KN 2.8 $10500 \pm \%7 \Omega$

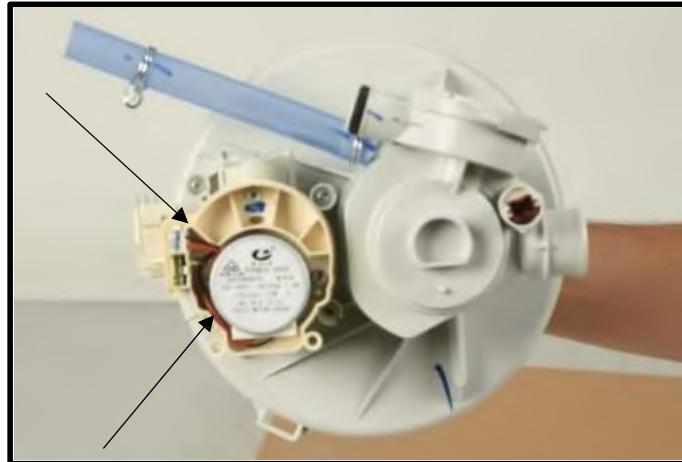
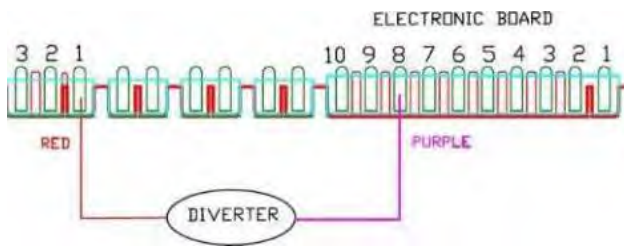

Sketch above show the connectors of the diverter on the electrical card. Probes of the tester should be applied on to the related connectors.

Measurement from the component:



Probes of the tester should be applied on to the related connectors as shown on the pictures.

2.9. Water Inlet Valve:

Single inlet and single outlet standard single coil selenoid valve.

Voltage	220 - 240
Total Power	6W
Flowrate	2,5 ±% 15 lt/dk
Coil Isolation Class	H
Resistance	4200 ±%10



It is assembled to the basement and connected to the airbreak by hose.

From the electrical Card:

	C	T
WATERINLET VALVE	CN2.6 - CN2.9 4200 Ω ± %10 (20°C)	KN2.6 - KN2.8 4200 Ω ± %10 (20°C)

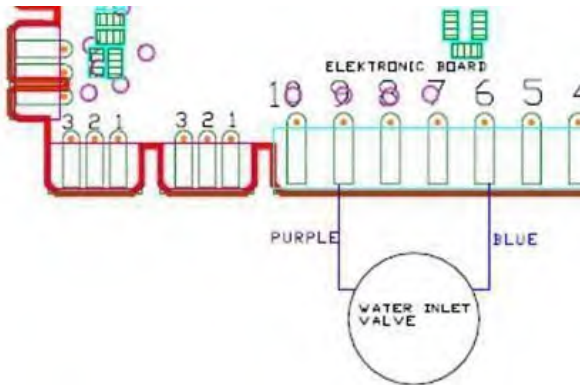

Above sketch show the connectors of the water inlet valve on the electrical card. Probes of the tester should be applied on to the related connectors.

From the component:



Probes of the tester should be applied on to the related connectors as shown on the pictures.

2.10. Regeneration Valve:

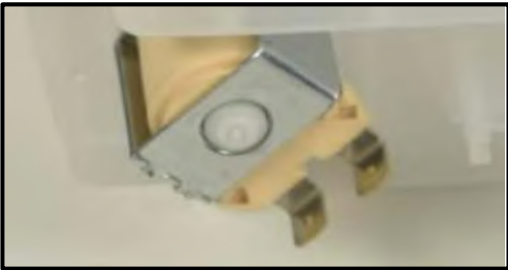

Voltage	220/240 V
Frequency	50/60 Hz
Total power	6 W
Resistance	$3560 \pm \% 10 \Omega^{\circ C}$

Regeneration valve is assembled on the water softener.

From the electrical Card:

	C	T
REGENERATION VALVE	CN2.2- CN2.7 $3560 \Omega \pm \%10(25^{\circ}C)$	KN2.2- KN2.10 $3560 \Omega \pm \%10(25^{\circ}C)$

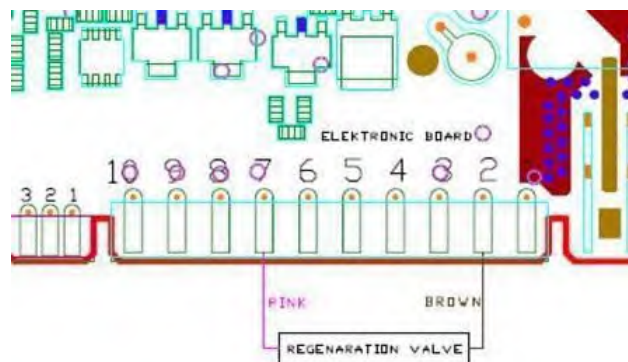

Above sketch show the connectors of the regeneration valve on the electrical card. Probes of the tester should be applied on to the related connectors.

From the component:



2.11. Parasite Filter

Voltage	220/240
Frequency	50/60 Hz

0,1 uF (X1) + 2x2,2 uF (Y2) + 1MΩ

It is used to prevent parasites from the main supply. It has been assembled to the base.

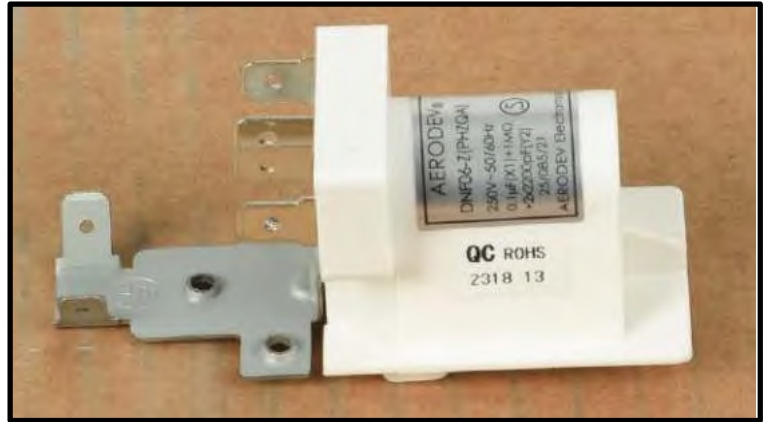

2.12. Turbo Fan:

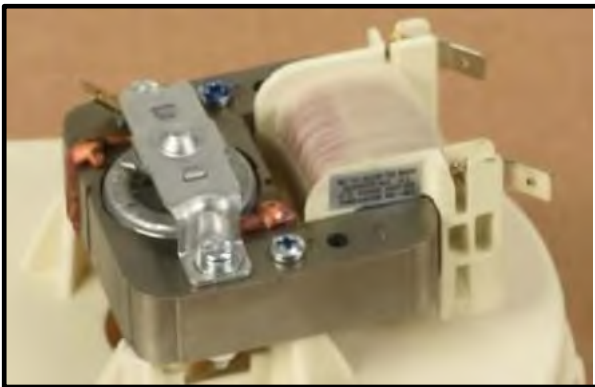

There is a thermal protector shaded pole motor, two pole temperature is between -40-150°C

There is turbo fan motor only at A models.

2.13. Salt Sensor



Voltage 250 V
 Currency 50 mA



It is assembled to the water softener.

It warns if the salt is less than requested quantity.

2.14. Power Cord:

Type	Electrical power cord
Material	PVC
Color	White
Length	1.5m

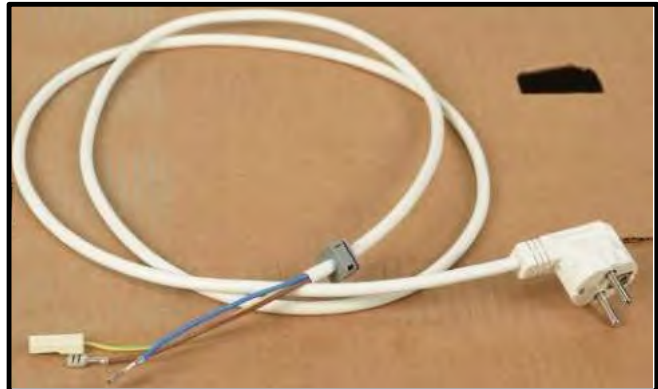

DRAIN HOSE



Drain hose maximum height	110 cm
Drain hose minimum height	50 cm
Drain hose maximum length	400 cm
Total Power	15 W
Voltage	220/240 V
Frequency	50 Hz
Resistance	238.6 ± 5 % Ω

Precaution: Always remove the plug from the power socket before touching internal components.

2.15. Rinse Aid Sensor:

Measurement from the electrical card:

	C		T		
RINSEAIDSENSOR	CN 5.3- CN 5.2	0Ω NO RINSE AID ∞Ω THERE IS RINSE AID	KN50.8- KN50.9	0Ω NO RINSE AID ∞Ω THERE IS RINSE AID	Rinse aid off Rinse aid on

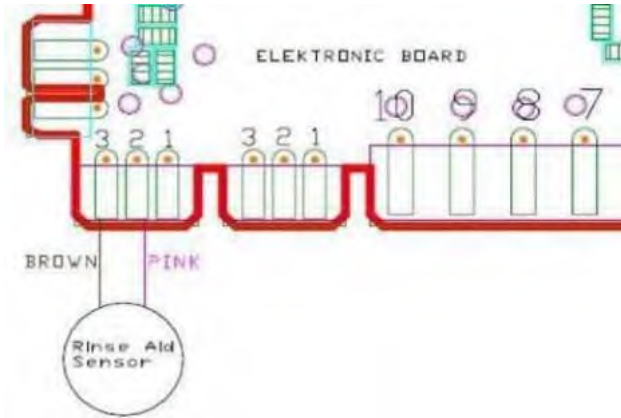

Above sketch shows the connectors of the rinse aid sensor on the electrical card.

From the component:

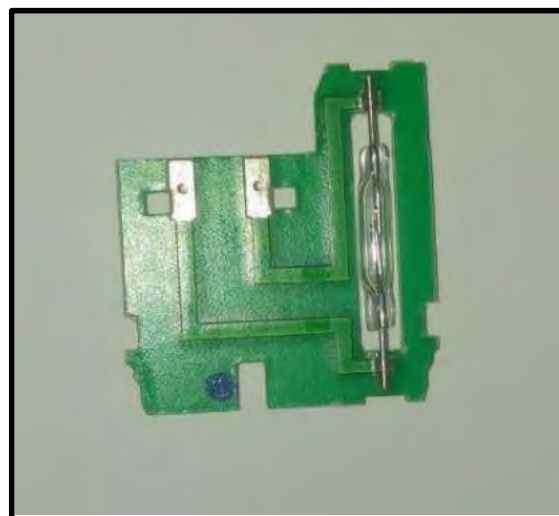
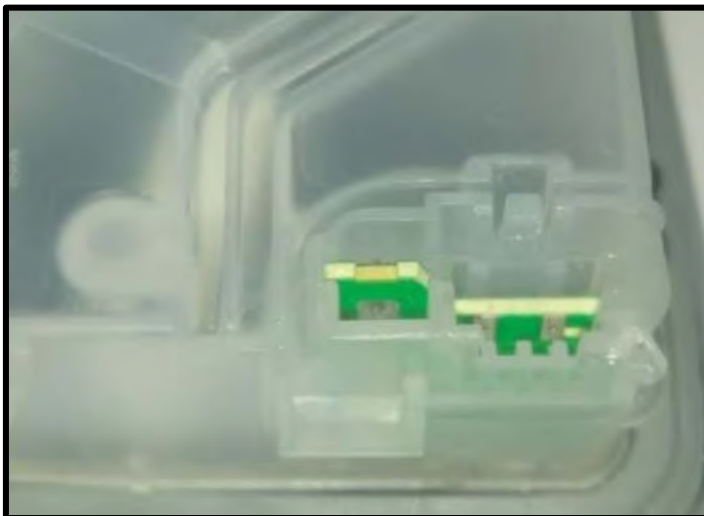

Probes of the tester should be applied on to the related connectors as shown on the pictures.

FAN MOTOR

From the electrical card:

	C	T
FANMOTOR	CN 6.2- CN 2.9	KN 6.2- KN 2.8

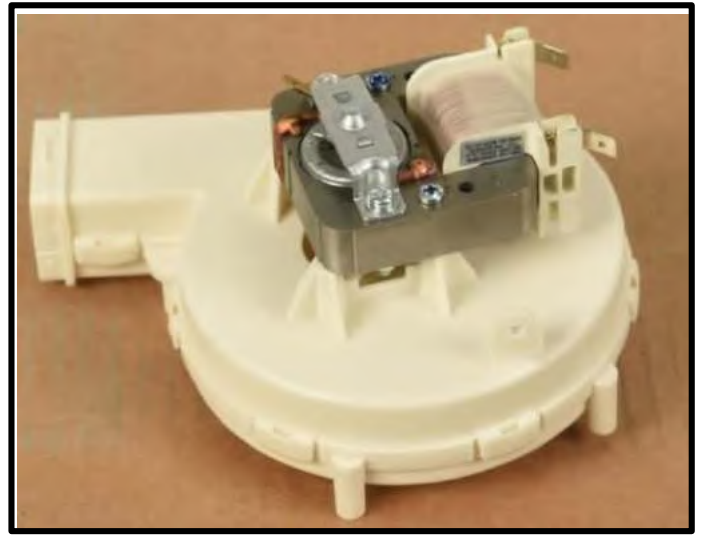
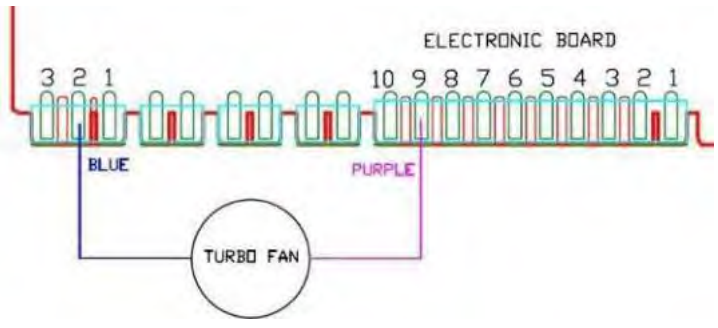

Above sketch shows the connectors of the fan motor on the electrical card.

From the component:



Turbo fan resistance value: $265 \pm 10\% \Omega$ (The resistance of the turbo fan is measured with the resistor switch).

2.16. Door Switch:

Measurement from the electrical card:

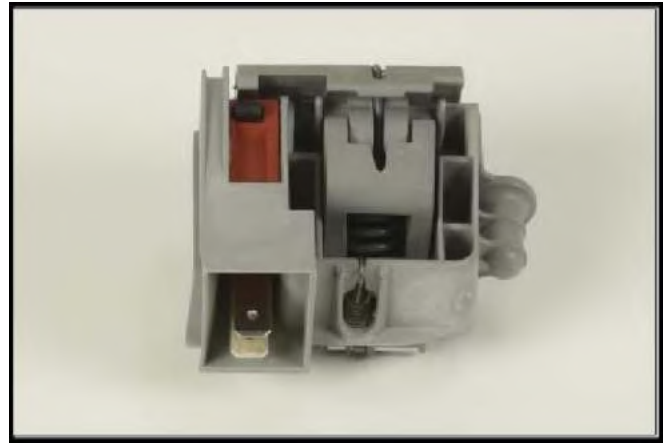
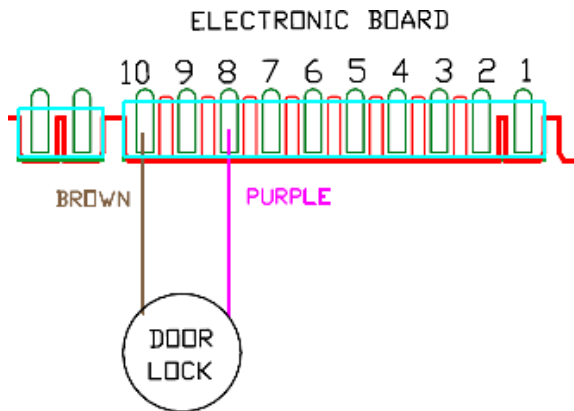

Above sketch show the connectors of the door switch on the electrical card.

Measurement from the component:

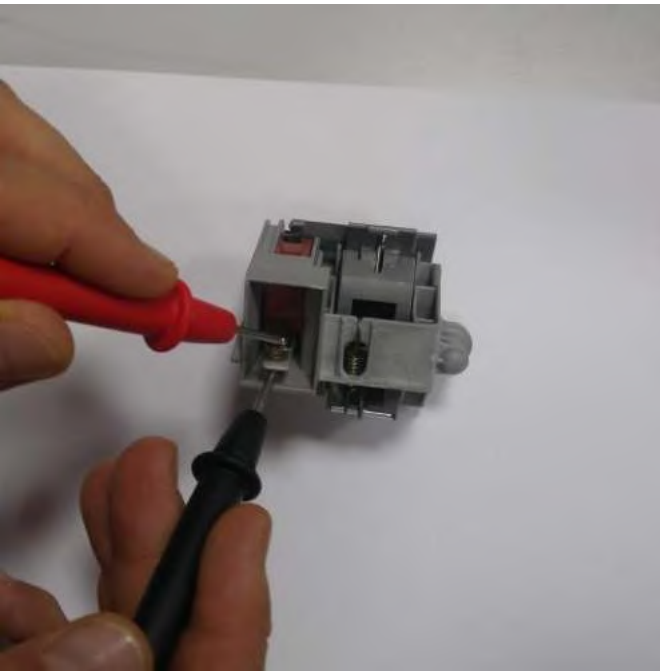

Probes of the tester should be applied on to the related connectors as shown on the pictures.

2.17. Floater:

Measurement from the electrical card:

	C	T	
FLOATER(MICROSWITCH)	CN2.1- CN 2.5 CN2.1- CN 2.4	0Ω ∞Ω	KN2.5- KN 2.10 KN2.4- KN 2.5
			0Ω ∞Ω
			Microswitch is inactive (no water) microswitch is active (there is water)

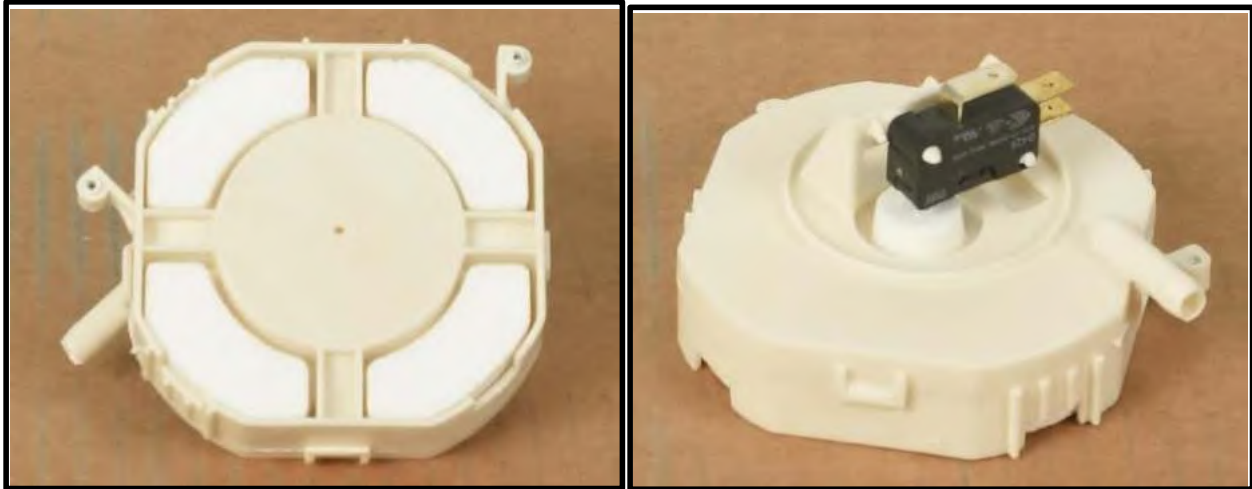

COM – NC contact		Normally: short circuit.
COM – NO Contact		Normally: open circuit.

2.18. Salt Sensor:

Measurement from the electronic card:

	C	T	
SALTSENSOR	CN5.1-CN5.2 0Ω NO SALT ∞Ω THERE IS SALT	KN50.10-KN50.11 0Ω NO SALT ∞Ω THERE IS SALT	Measure just on the electronic

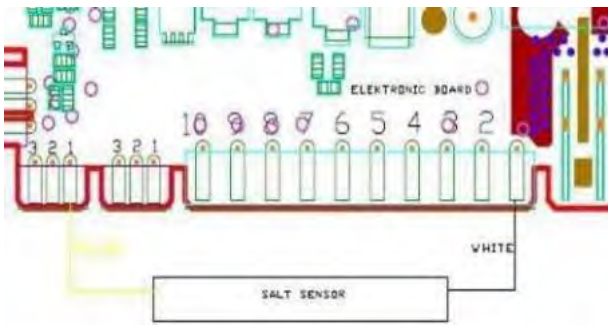

Sketch above show the connectors of the salt sensor on the electronic card. Probes of the tester should be applied on the related connectors.

Measurement from the component:



Ssalt sensor can also be measured from the water softener when the salt sensor is assembled on the water softener.

Probes of the tester should be applied on to the related connectors as shown on the pictures.

2.19. Pressure Switch:

Measurement from the electronic card:

	C		T		
PRESSURESWITCH	CN2.10-CN2.2	0Ω ∞Ω	KN2.9-KN2.10	0Ω ∞Ω	Full fill water nowater

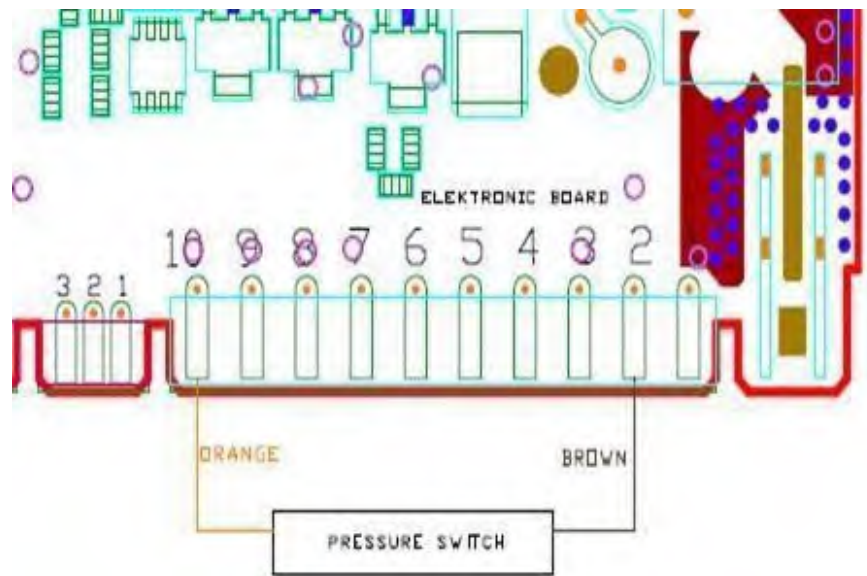

Measurement from the component:



Probes of the tester should be applied on to the related connectors as shown in the picture above.

2.20. Detergent Dispenser:

It can't be measured from the electronical card:



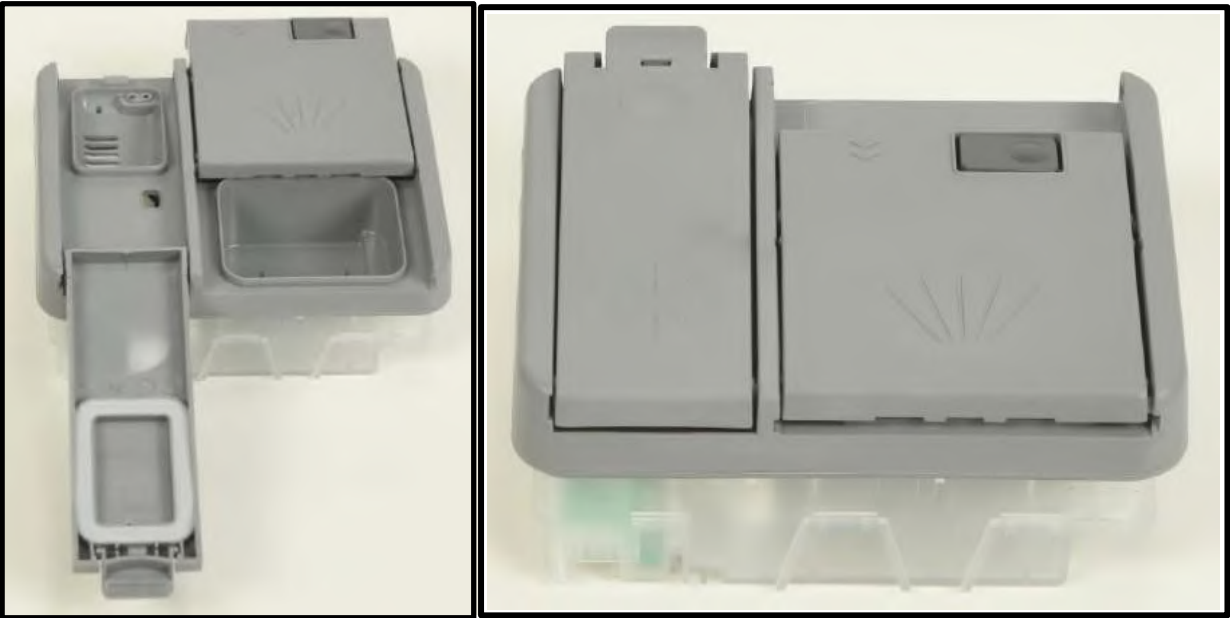

	C	T
DETERGENT DISPENSER	2300Ω ±%10 (25 C°)	2300Ω ±%10 (25 C°)

Measured from the component.



3. DISASSEMBLY OF COMPONENTS

3.1. Tools to Be Used

Name	Picture	Purpose of Use
Philips Screwdriver And Chargable Screwdriver		To assemble and disassemble of star-head screws
Flat Screwdriver		To help the assemble and disassemble of plastic parts (side panels, front panels and external aesthetic parts of the machine)
Plier		To assemble and disassemble of clamps
Multimeter		To measure the electrical components in the machine and electronic components on the electronic boards

CAUTION!: REMOVE ELECTRIC PLUG FROM THE SOCKET DURING THE DISASSEMBLY

3.2. Assembly and Disassembly Instructions of Components

3.2.1. Top Plate:

- a) Remove two screws that fix the top plate at the back.
- b) Push the top-plate back and pull it up.

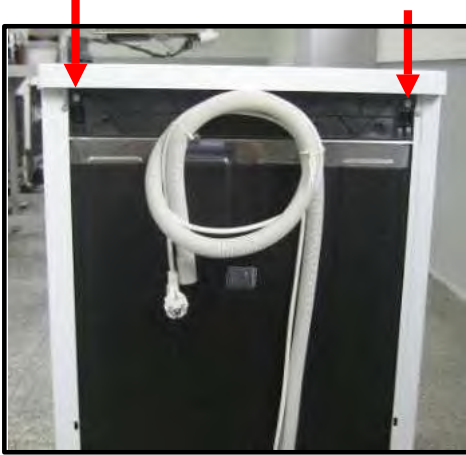

3.2.2. Plastic Kick Plate:

- a) Remove two screws fixing plastic kick plate.

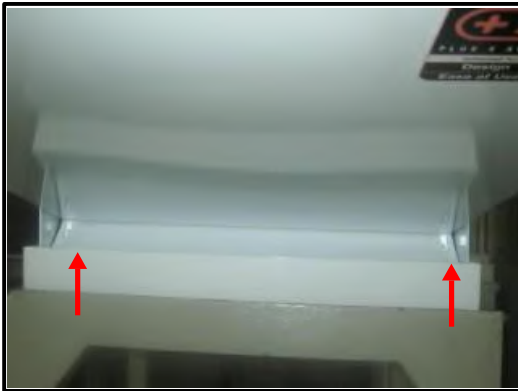

- b) Remove the plastic kick plate as it is shown in the picture.



3.2.3. Internal Feeding Tube and Spray Arms:

a) Unscrew the feed channel tabs with the help of a screwdriver

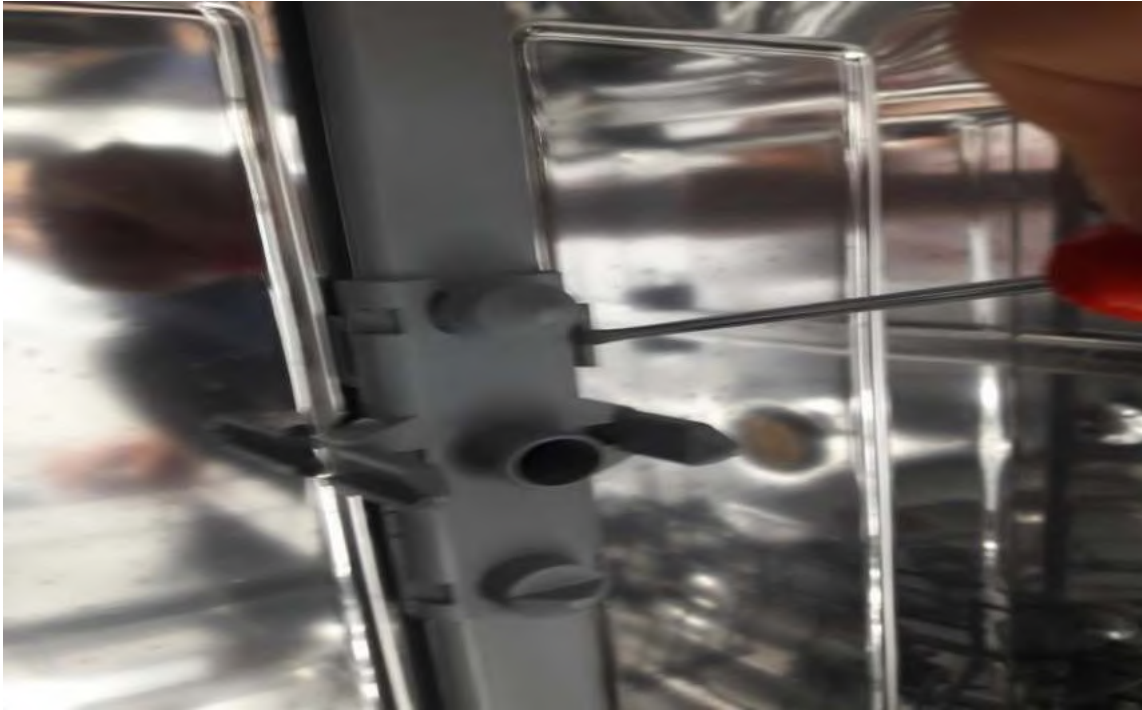

To assemble, manually narrow the feed channel replacement and insert it into the tabs

Pull out the top spray channel by turning it clockwise

Turn it counterclockwise to reinstall it
kindly pull it up

b) To remove the lower spray arm,



3.2.4. Micro Filter and Metal Filter:

- a) Open the door.
- b) Remove lower basket
- c) To remove microfilter group rotate them in the direction of counter clockwise and pull them up as it is shown in the picture



- d) To remove microfilter group (course filter and micro filter) pull them as it is shown in the picture.



- e) To remove the metal filter pull it up as it shown in the picture.



3.2.5. Draining hose:



- a) Remove the hose connection plastic.
- b) Remove lower cover.
- c) Remove the clamp that fixes draining hose to the sump
- d) Remove draining hose

3.2.6. Lower basket

- a) Open machine's door.
- b) Pull the basket to yourself.



3.2.7. Upper basket

- a) Open upper basket rail lock front.
Pull the basket to yourself and remove it.



3.2.8. Water Inlet valve

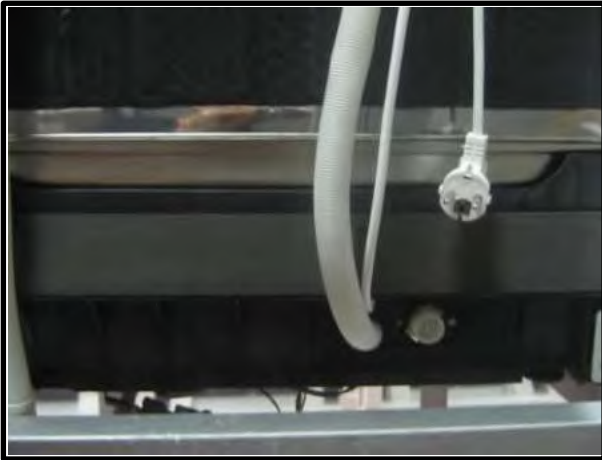

a) Remove lower cover.

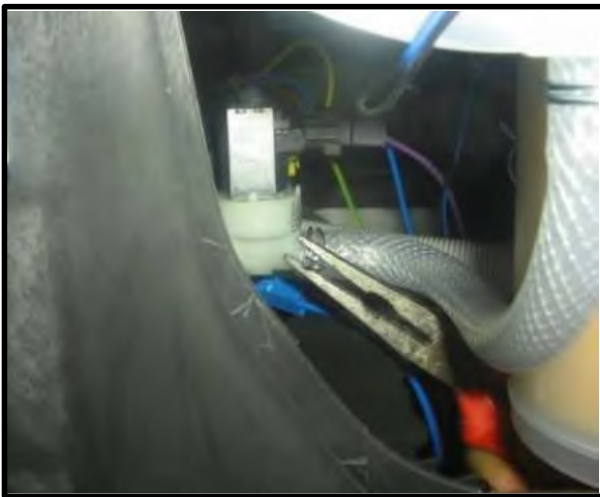

b) Remove the wire that is connected to the water inlet valve.

c) Remove the clamp that connects water inlet valve and air-break as it is shown in the picture

To remove water inlet valve pull it back as it is shown in the direction of picture then release water inlet valve from the pins that is connecte to and rotate it in the direction of counterclockwise.



3.2.9. Turbo Fan

a) Remove top tray



b) Remove the side panel rear and front screws



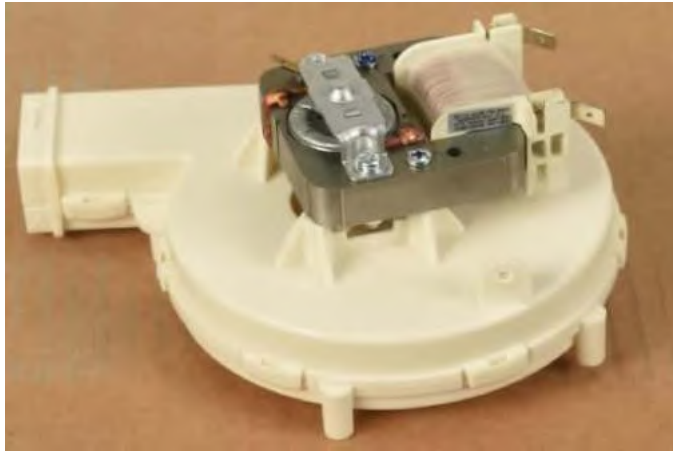

- c) Disconnect turbo fan cables
- d) Disconnect the condensate unit from the turbo fan.



- e) Remove the turbo fan screws



- f) Remove the turbo fan.

To reassemble, before connect the cables, install the screws, install the condensate unit.

3.2.10. Sump Group

- a) Remove 2 screws on top



sump screws

- b) Remove the drain pump



- c) Remove the drain hose



- d) Remove the blue hose from the water softener to the pool group



blue hose

- e) Unscrew eco or diverter part(it is changeable) screws
f) Then get the sump



- g) Disconnect heater hose

To assemble, connect the cables and screws in same way.

3.2.11. Floater

a) Remove lower cover.



b) Remove two screws that fix floater as it is shown in the picture.



c) Remove the floater hose.



d) Remove the connectors



e) Make sure the connectors are inserted properly as in the photos.



WARNING: During the disassembly and assembly of the component, it must be ensured that the electrical connection connectors are fully and properly inserted. An electrical connector that is not fully inserted during service intervention may cause a fire.

f) Make sure that the PC film over the switch is in proper shape and position as in the photos.

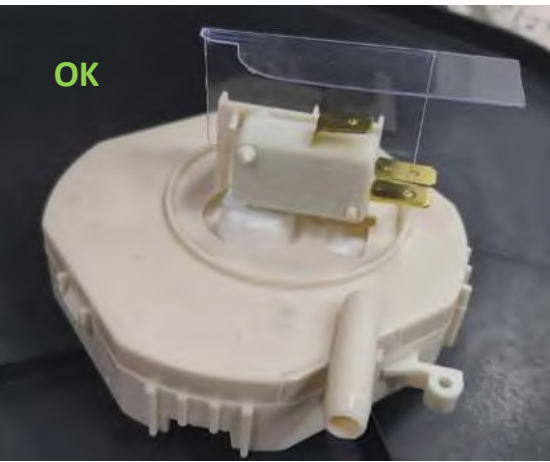

g) Make sure that the screw holes are in correct position for correct assembly.

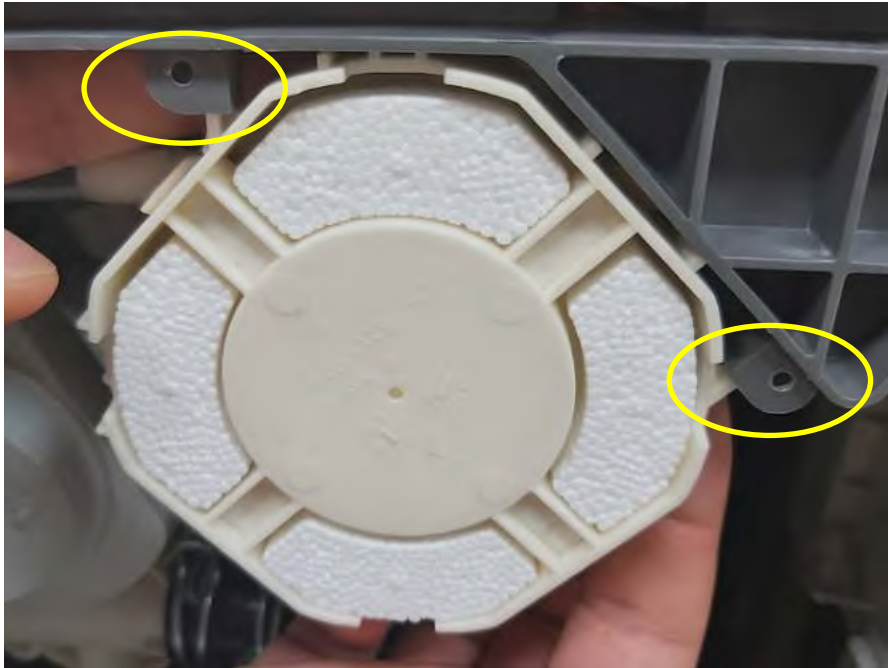

3.2.12. Water softener



- a) To remove salt cup cover, rotate it in the direction of counterclockwise
- b) To remove salt cup nut, rotate it in the direction of counterclockwise.
- c) Remove left side panel.
- d) Derach the connections which are between water softener and air-break.

e) Remove lower cover.

f) Remove the hose that is between sump and salt camp.



3.2.13. Parasite filter



- a) Remove lower cover.
- b) Remove one screw fixing parasite filter.
- c) Remove wires.
- d) Push parasite filter and remove it.



WARNING: During the disassembly and assembly of the component, it must be ensured that the electrical connection connectors are fully and properly inserted. An electrical connector that is not fully inserted during service intervention may cause a fire.

3.2.14. Diverter

- a) Disconnect the diverter cables
- b) Disconnect pressure switch cables

pressure switch



In order to remove the divider from the pool part, the 4 screws indicated by the red arrow must be removed.

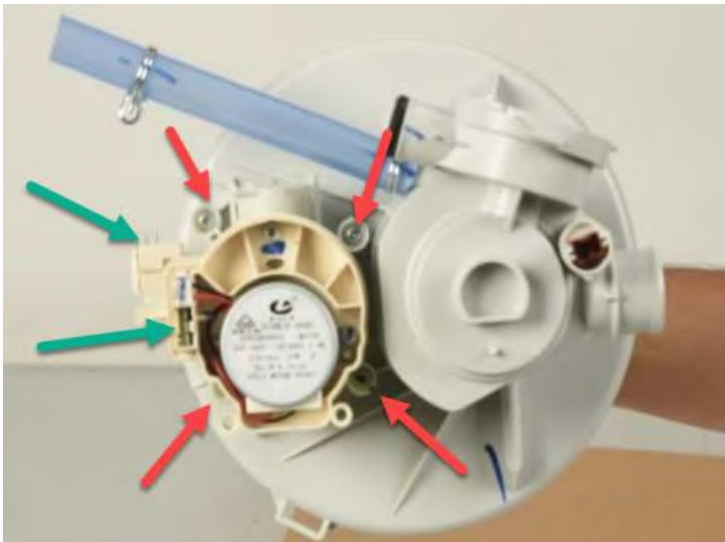

WARNING: During the disassembly and assembly of the component, it must be ensured that the electrical connection connectors are fully and properly inserted. An electrical connector that is not fully inserted during service intervention may cause a fire.

- c) Disconnect turbidity sensor cables(if the machine has)
 - d) Unscrew the diverter screws
 - e) Pull the clamps with pliers (Diverter clamp is next to the circulation pump's clamp. Please see in the circulation pump removal instruction page).
- 3.2.15. Lower Cover:
- a. Lay the appliance on the rear panel.



- b. Remove lower cover from the places that are shown in the picture.

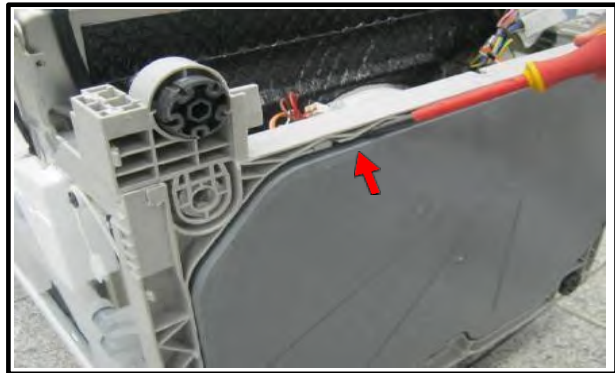
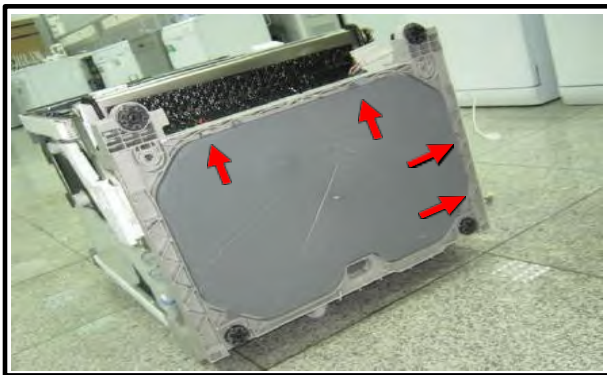

3.2.16. Circulation Pump

- a) Push the 2 clamps upwards.



WARNING: During the disassembly and assembly of the component, it must be ensured that the electrical connection connectors are fully and properly inserted. An electrical connector that is not fully inserted during service intervention may cause a fire.

b) Remove the straps from both sides



3.2.17. Regeneration valve:

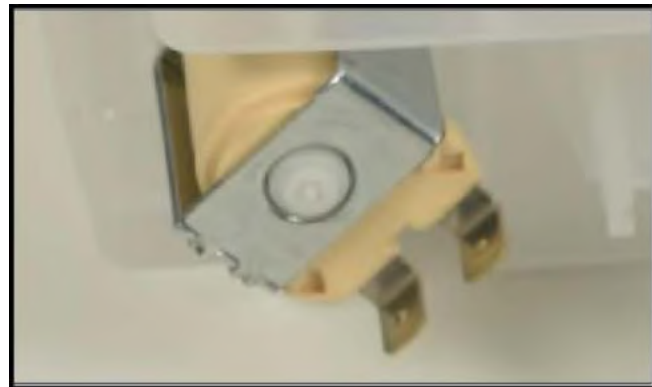

- a) Remove plastic kick plate and kick plate iron sheet.
- b) Remove the wires
- c) To remove regeneration Value rotate counterclockwise and pull it as it is shown in the picture.

3.2.18. Drain pump:



- a) Remove plastic kick plate and kick plate iron sheet
- b) Remove the wires.
- c) To remove the drain pump that fixes to the sump, rotate it in the direction of counterclockwise and pull.



WARNING: During the disassembly and assembly of the component, it must be ensured that the electrical connection connectors are fully and properly inserted. An electrical connector that is not fully inserted during service intervention may cause a fire.

3.2.19. Power cord:

- a) Remove hose connection plastic.



- b) Remove the lower cover.
- c) Remove the wires that is between power cord and parasite filter.
- d) Remove the power cord.



WARNING: During the disassembly and assembly of the component, it must be ensured that the electrical connection connectors are fully and properly inserted. An electrical connector that is not fully inserted during service intervention may cause a fire.

3.2.20. Hose connection plastic:

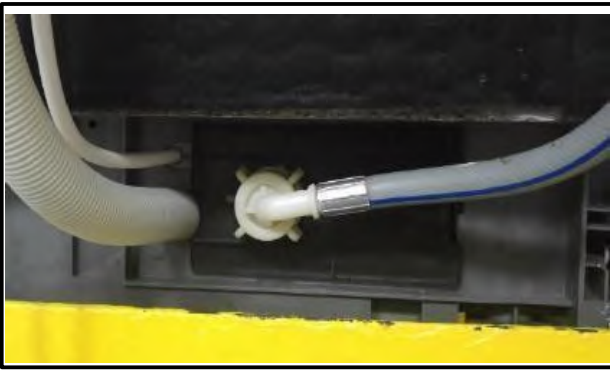

a) Remove left side panel.



b) By using flat tip screwdriver remove hose connection plastic's hinge from the basement as it shown in the picture

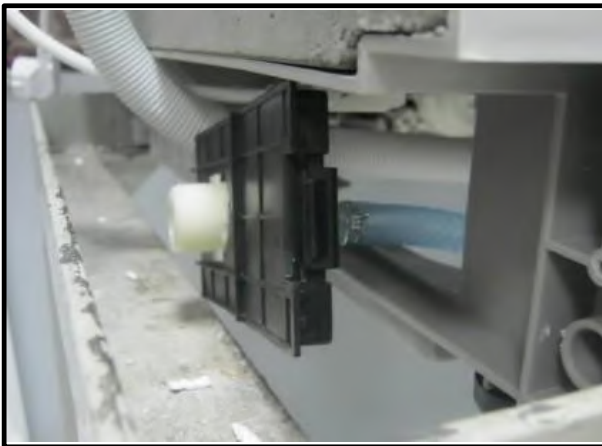

c) Push the hose connection plastic.

Warning:

If the instructions are not applied during disassembly, the hose connection plastic can be broken.

3.2.21. Airbreak:



- a) Remove the left side panel of the machine.
- b) Open machine's door
- c) Rotate counterclockwise air-break nut and remove it.

d) Remove air-break's connections with salt cap as it is shown in the picture. (be careful about plastic hinges)



3.2.22. Door Hinge:

- a) Remove side panels.
- b) Remove Hinge Spring.



c) Pull the door inside up as It is shown in the picture.

Door spring

d) Remove two screws that fix hinge movement sheet iron to the door inside.



3.2.23. Dispenser:

- a) Remove front panel
- b) Disconnect the dispenser cable harness.



- c) Remove the metal tabs on the top, bottom and sides to disengage the dispenser.



- d) To assemble, tighten the metal tabs with a pliers.
- e) After applying silicone oil or liquid soap to dispenser, press down and engaged dispenser.



3.2.24. Door Lock:

a) Remove control panel screws

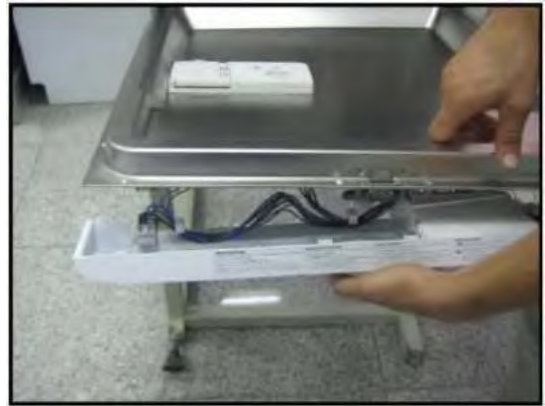

b) Disconnect cable connections with door lock



c) Remove two door lock screws



3.2.25. Electronic Board:

a) Remove top tray:



b) Remove side panel



c) Remove side panel support styrofoam

d) Pull up the pcb box



- e) Disconnect cable connections from cable harness
- f) Remove the tabs and take the electronic card
- g) To assemble, reinsert the pcb box into the tabs.

3.2.26. Control Panel:

- a) Remove 6 screws that fix control panel to the door inside sheet iron.
- c) Remove the control panel group carefully as shown in the picture



- c) Remove the cable connection plastic which fix cable harness to the control panel as shown in the picture.
- d) Remove the wires that are connected to control panel group.



3.2.27. Kick Plate Sheet Iron

- a) Remove top plate, plastic kick plate and side panels.
- b) Remove the screws (4 screws) that fix the kick plate sheet iron.
- c) Pull it down as shown in the picture.



- d) To remove the side panel, remove the upper plastic hinge and then the above one and pull it up.



3.2.28. Front Panel

a) Remove the screws as it shown in the picture.



b) Pull down the front panel after removing the screws.

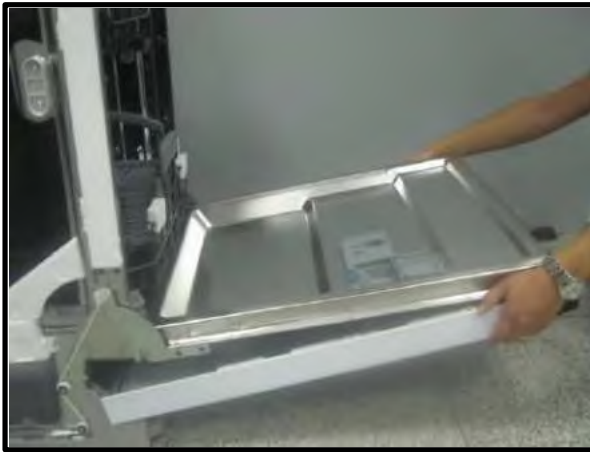

3.2.29. Side panels

1) Remove top table screws



Top Tray screws

2) Remove the side panel rear screws



Side panel rear screws

3) Remove the kick plate plastic after removing the front panel



Plastic kick plate screw

4) Remove the side panel front screws



5) Remove the side panel rear tabs



6) Remove the side panel front tabs



3.2.30. Inner Light Source:

1) Remove top tray



2) Remove side panel



3) Remove side panel support styrofoam

4) Remove the cables



5) Rotate counterclockwise nut and remove it.

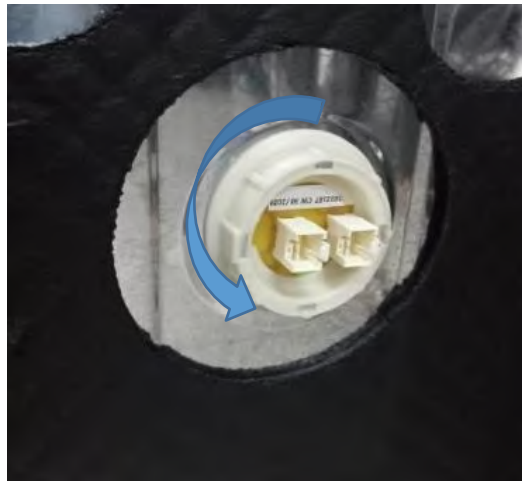

Note: This visual is representative sample Note: This visual is representative sample.



OKAM MATTERS TO BE CONSIDERED IN ASSEMBLY OF THE MECHANISM ASSEMBLY

1_ OKAM In order to assemble and disassemble the mechanism, the top plate and the two right-left side panels must be removed.

2_ OKAM mechanism 220V supply cable assembly and route must be appropriate.

In models with water recovery tank;

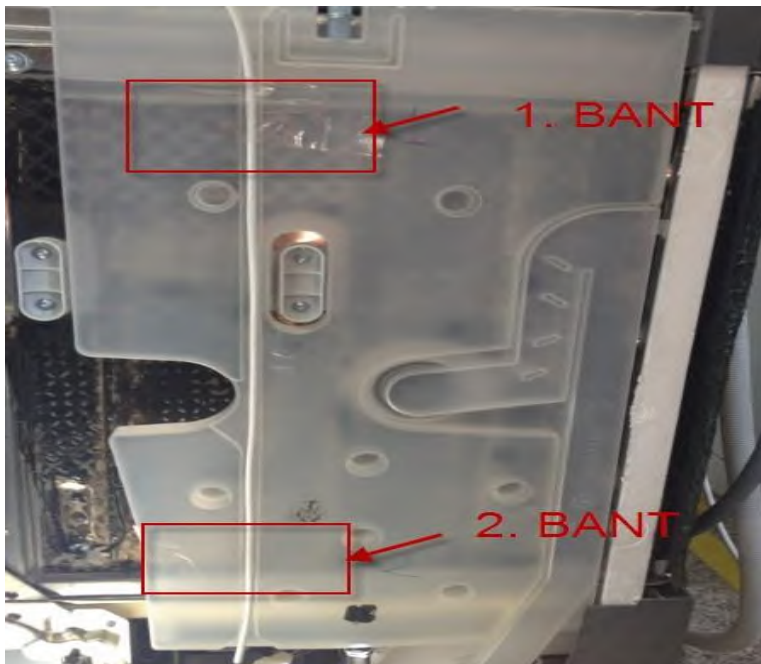

3 _ For Machines Without Water Tank:

OKAM cable will be lowered by leaning to the right of the rear rail bracket on machines with door opening feature and without water tank. The banding will be at the 2 points shown below.

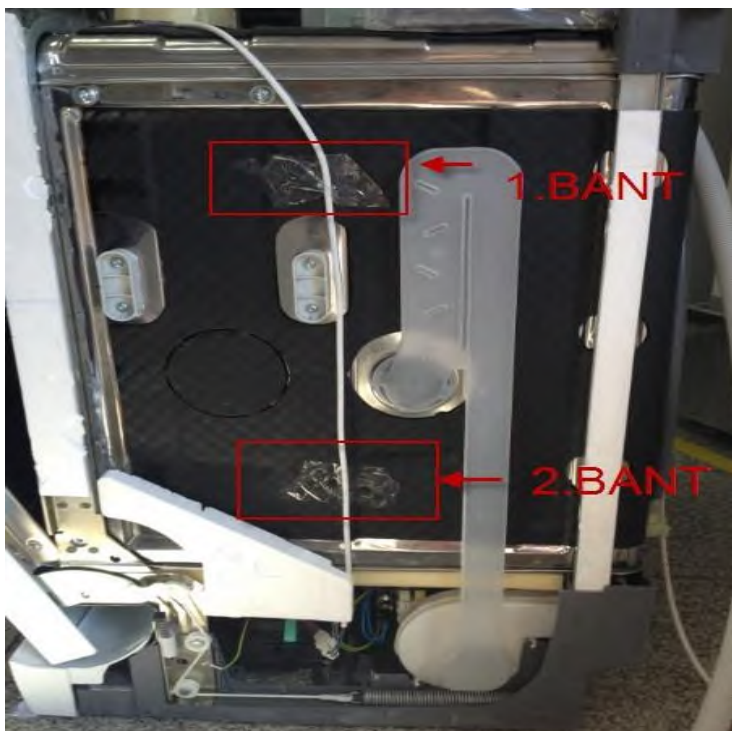

4_ OKAM The spring assembly should be screwed onto the fixed hinge and the movable hinge spring should press on the mechanism centrally, there should be no deformation in the springs.

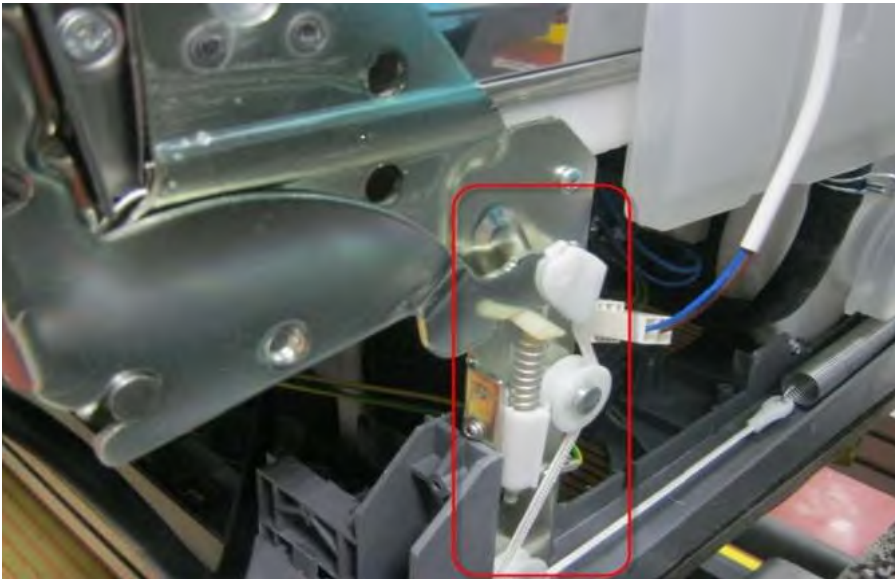

5_ OKAM In the machines with the drying mechanism, the mechanism crank should open the door by pushing the door outwards at the end of the drying step, then the shaft should be slowly pulled inward after cooling within 30 seconds.



6_ OKAM assembly socket assembly must be appropriate and ensure that it is fully seated.



3.2.31. Aluminum Foil Tape of Handle on Control Panel:

This is applied to ANGEL, CARYA AND DAISY model control panels.



Al foil in the handle area

Removal of The Foil:

a) Slowly remove the Al foil upwards in the direction of the arrow, as shown in the picture, in the order below.



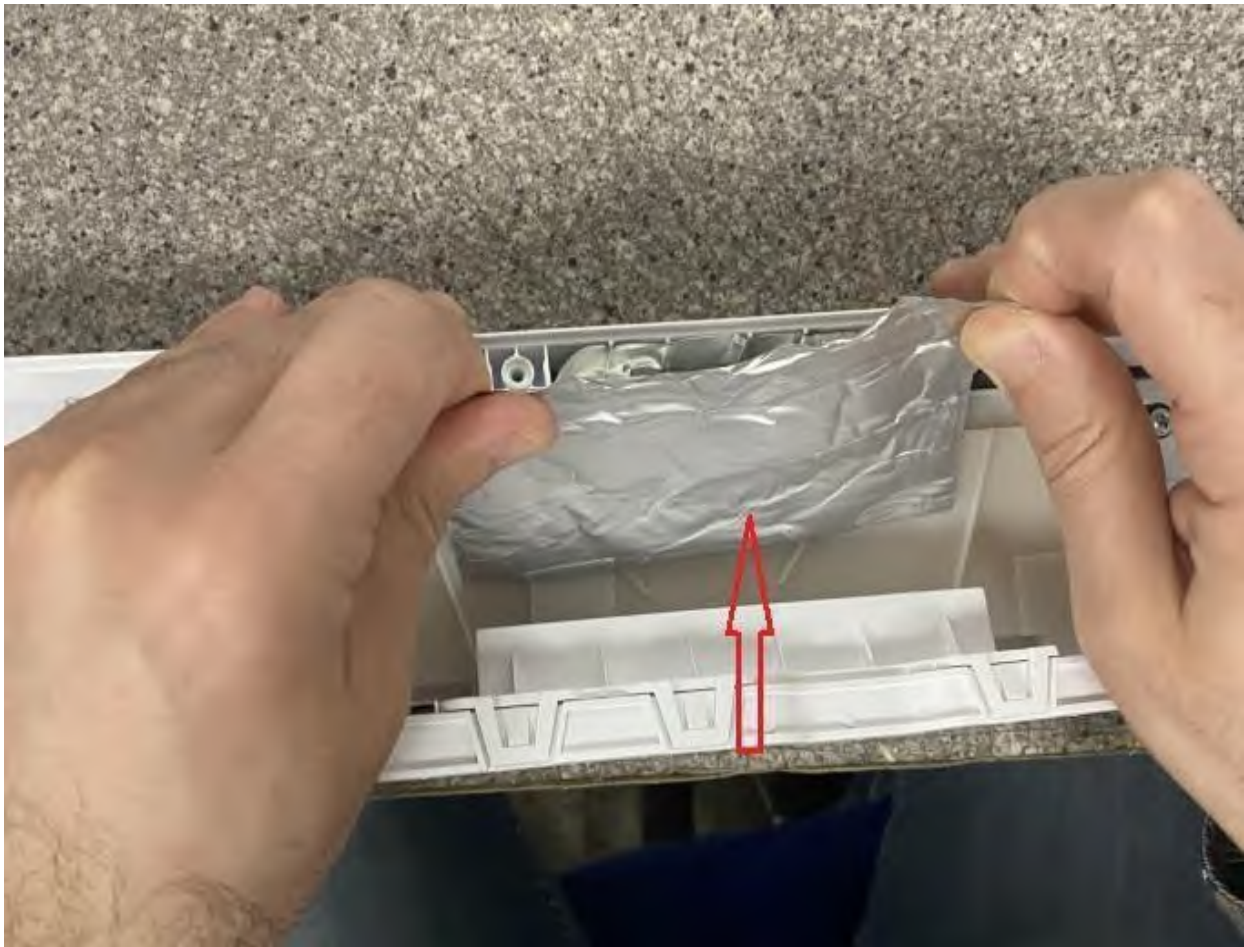

b) According to the processing below, as seen in the picture, after the Al foil is removed, access to the handle and display card is provided, respectively.

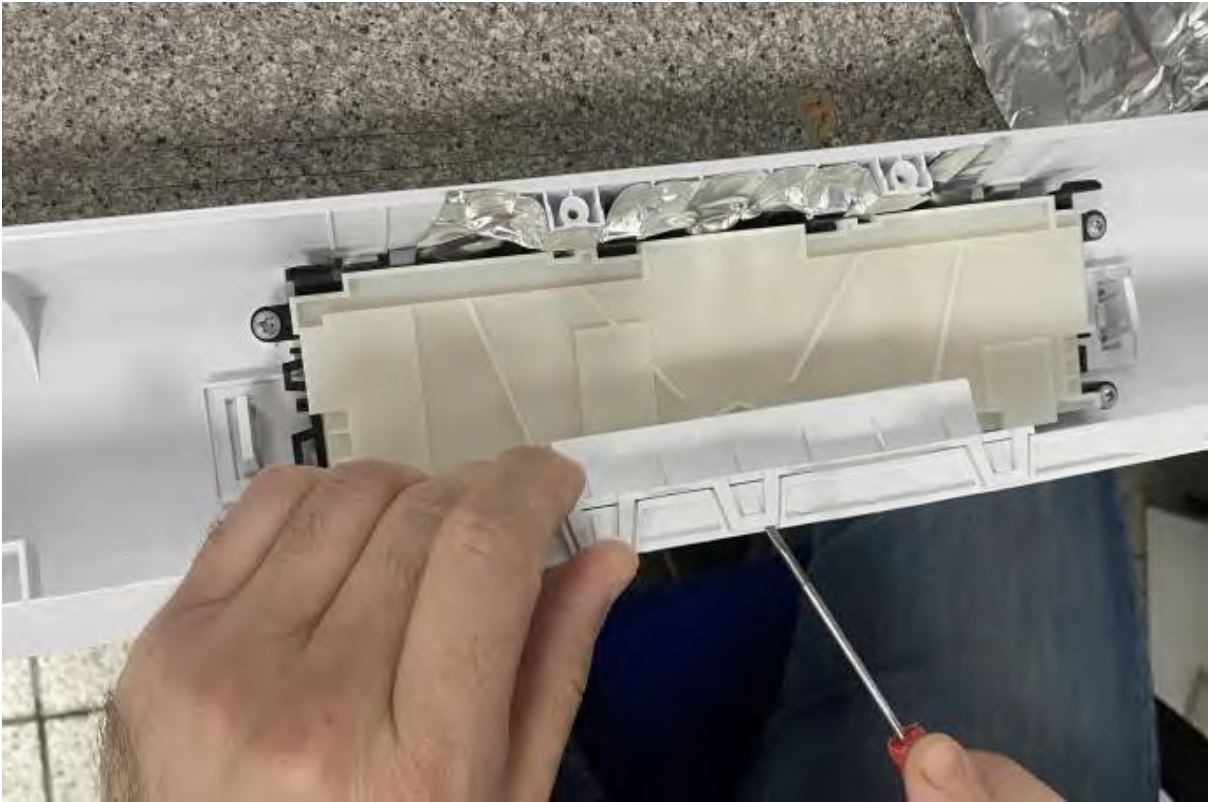

Assembly of the Foil:

a) Replace the handle as follows.

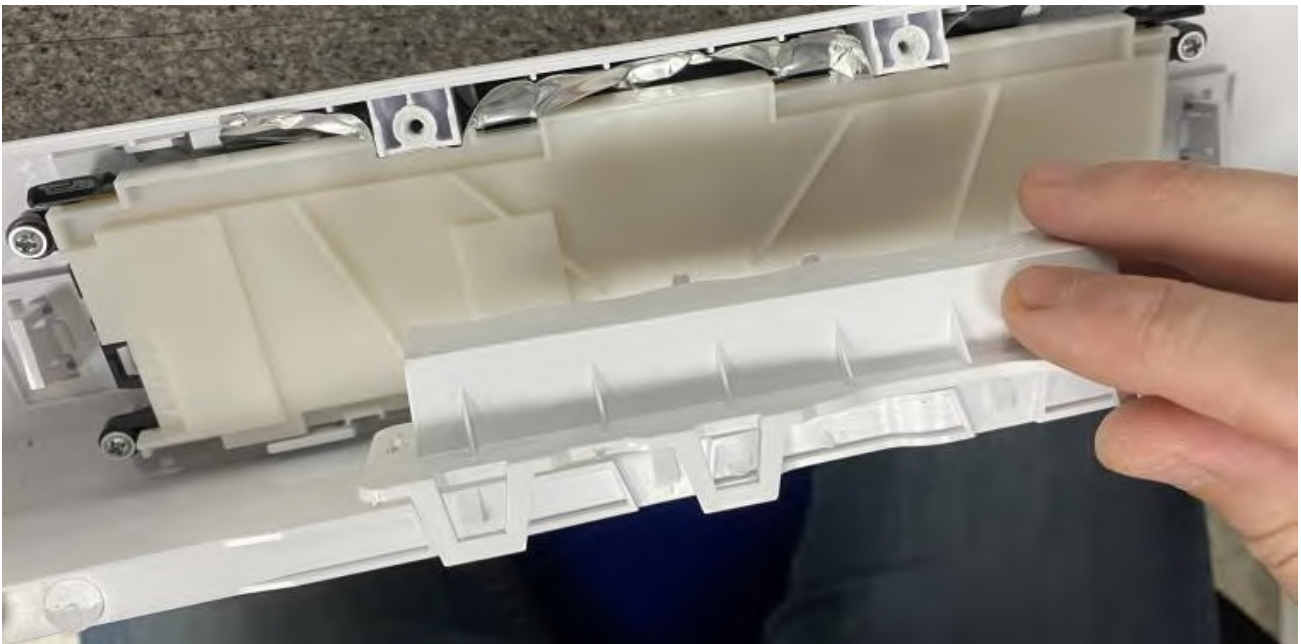



b) Remove the rear protective tape of the Al foil.



c) After removing the back protective tape of the Al foil, place the tape as shown below so that there is no gap at the top.



d) After placing it so that there is no gap at the top of the Al foil, stick it down in the direction of the arrow and proceed slowly.

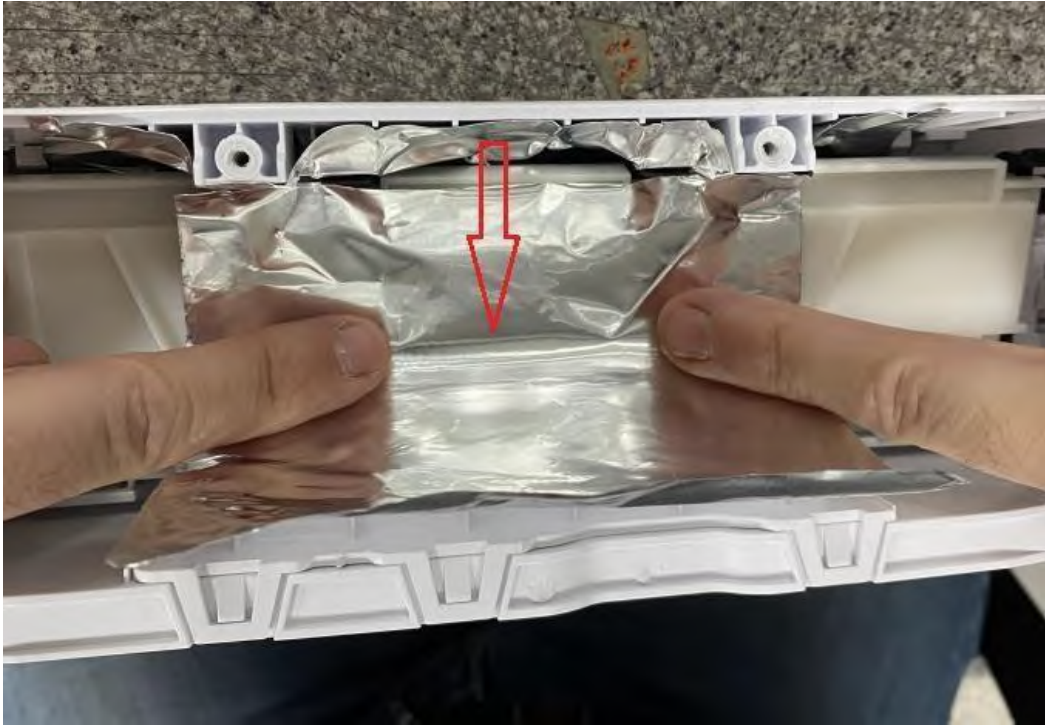

e) Move the Al foil downwards in the direction of the arrow, by sticking the tape slowly according to the figures, without leaving any gaps.



f) Glue the gap of the aluminum foil by bending it downwards.



Aluminum foil codes are as below according to panel type:

NO	Control Panel Aesthetic Name	AL FOIL MATERIAL CODE
1	ANGEL	47018017
2	DAISY	47018017
3	CARYA	47018017

3.2.32. NTC
Disconnect ntc cables

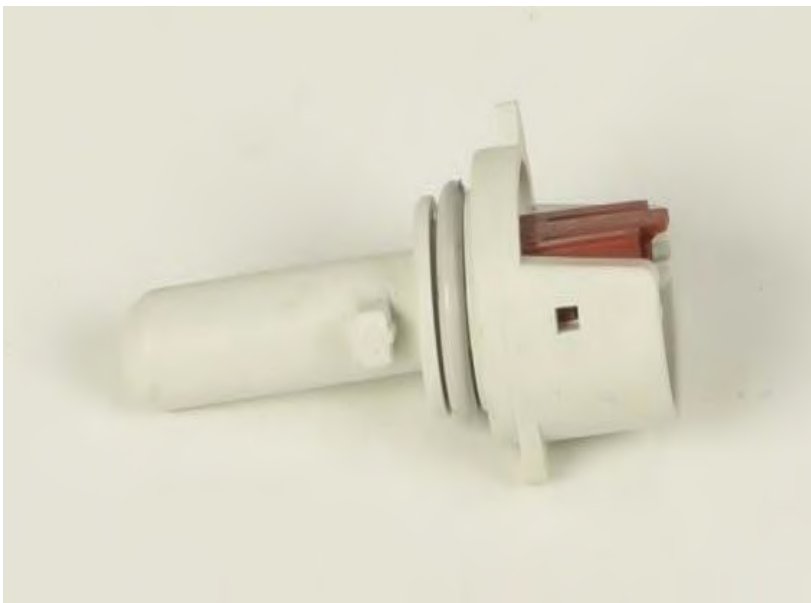

3.2.33. Heater

- a) Remove 2 clamps



- b) Disconnect cable connections and get the heater

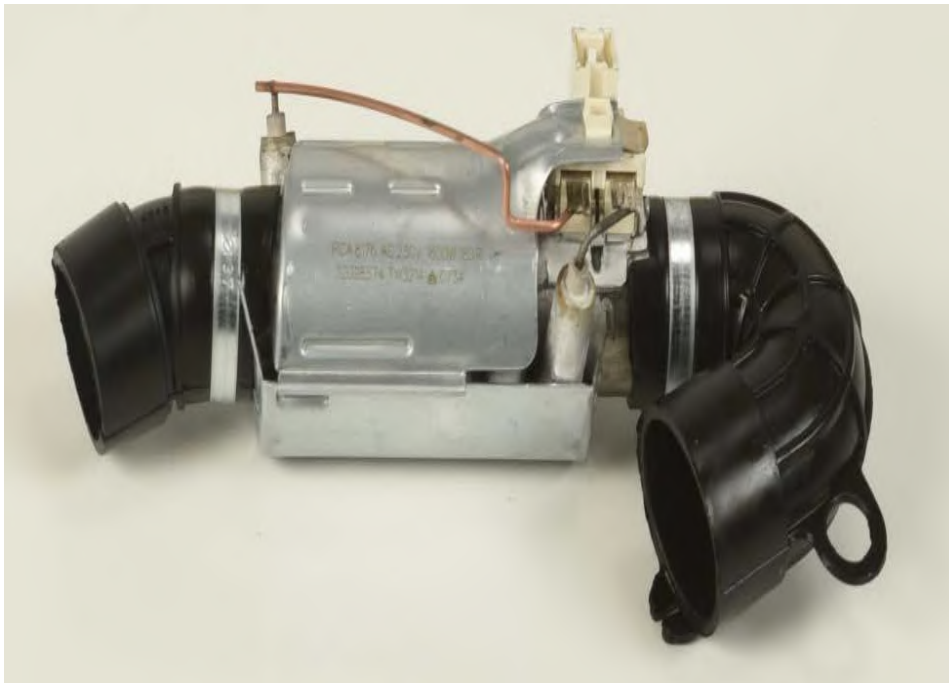

To assemble, the cables are connected first and the screws are attached.